

2026 CATALOGUE GÉNÉRAL

Ensemble, pour une  
création impactante.



Concevons ensemble des solutions créatives  
pour rendre votre marque encore plus remarquable.

**Think BIC**



 **BIC**<sup>®</sup> *graphic*  
Your Brand Ambassador



Notre histoire a commencé en 1944,  
faisant partie du quotidien. Aujourd'hui,  
nous sommes également aux côtés des  
marques, en les positionnant au meilleur  
endroit du monde : dans la vie des gens.



*Découvrez comment !*



## BIC GRAPHIC

2

Notre histoire	2	Produits durables	20
Bienvenue dans l'univers du BIC...	6	Nouveautés Ecolutions®	22
C'est pourquoi nous vous invitons à : Créer avec nous	8	BIC® 4 Couleurs® ECO	24
Une Icône	10	BIC® Media Clic Advance	26
Connexion	12	BIC® Cristal® Re'New™ Black	28
Confiance	14	BIC® M10® Clic	30
Personnalisons chaque produit de manière responsable.	16	BIC® Highlighter Flat	32
Innovation durable	18		

## INSTRUMENTS D'ÉCRITURE BIC®

34

### STYLOS

BIC® Cristal® Expression	38	BIC® 4 Couleurs® Gradient	124
BIC® Cristal® Re'New™	40	BIC® 4 Couleurs® Pastel	126
BIC® Cristal® Re'New™ Black	42	BIC® 4 Couleurs® Fashion	128
BIC® Style	44	BIC® 4 Couleurs® Sun	130
BIC® Round Stic®	48	BIC® 4 Couleurs® Fine	132
BIC® Round Stic® Ecolutions®	51	BIC® 4 Couleurs® Fluo	134
BIC® M10® Clic	54	BIC® 4 Couleurs® Glacé	136
BIC® Media Clic	60	BIC® 4 Couleurs® Shine	138
BIC® Media Clic Advance	58	BIC® 4 Couleurs® Soft	140
BIC® Media Clic Ecolutions®	61	BIC® 4 Couleurs® Wood Style	142
BIC® Media Clic Ecolutions® Plus	62	BIC® 4 Couleurs® Flags Collection	144
BIC® Media Clic Grip	65	BIC® 4 Couleurs® 3+1 <sup>HB</sup>	146
BIC® Media Clic Grip Ecolutions®	66		
BIC® Media Clic BGuard™ antibactérien	70	<b>STYLOS EN MÉTAL</b>	
BIC® Media Clic BGuard™ antimicrobial Ecolutions®	72	BIC® Metal Pro	148
BIC® Media Clic Biobased Ecolutions®	74		
BIC® Media Clic Biobased BGuard™ antibactérien	76	<b>ROLLERS ET GELS</b>	
BIC® Media Clic Shine	78	BIC® Grip Roller	154
BIC® Media Clic Glacé	80	BIC® Intensity® Gel Clic	156
BIC® Clic Stic	82		
BIC® Clic Stic Ecolutions®	83	<b>SURLIGNEURS ET MARQUEURS</b>	
BIC® Clic Stic Softfeel®	85	BIC® Brite Liner® Grip	160
BIC® Clic Stic Stylus	86	BIC® Highlighter Flat	162
BIC® Clic Stic Stylus Ecolutions®	86	BIC® Velleda® White Board Marker Fine	164
BIC® Super Clip	92	BIC® Velleda® White Board Marker Grip	165
BIC® Super Clip Ecolutions®	93	BIC® Mark-It Permanent Marker	166
BIC® Super Clip Advance	96	BIC® Permanent Marker Ecolutions®	167
BIC® Super Clip Glacé	96		
BIC® Super Clip Glacé Advance	100	<b>PORTE-MINES</b>	
BIC® Super Clip Soft	102	BIC® Matic®	170
BIC® Super Clip Soft Advance	103	BIC® Media Clic Porte-mines	172
BIC® Super Clip Origin	104	BIC® Media Clic Grip Porte-mines	173
BIC® Wide Body™	108	BIC® Media Clic Grip Porte-mines Ecolutions®	173
BIC® Wide Body™ Ecolutions®	109		
BIC® Wide Body™ Mini Digital	110	<b>PENCILS</b>	
BIC® 4 Couleurs®	116	BIC® Evolution® Ecolutions®	178
BIC® 4 Couleurs® ECO	118	BIC® Kids Evolution® Colouring Set	182
BIC® 4 Couleurs® Rainbow Decor	120	Sprout™ Crayon Graphite	184
BIC® 4 Couleurs® Bicolor	122		

---

## AUTRES INSTRUMENTS D'ÉCRITURE 186

### PLASTIC PENS

Basic Pen	190
Click Pen	192
Striped Grip Pen	194

### STYLUS PENS

Sleek Stylus Pen	198
------------------	-----

---

## CARNETS 200

### BIC® PARTNER

BIC® Partner Hard Cover	204	BIC® Partner FruitCover	208
BIC® Partner Flex Cover	206	BIC® Partner Carnets Tailormade Service	210

---

## BRIQUETS ET ÉTUIS BIC® / DJEEP® 212

### BRIQUETS BIC®

BIC® J25 Briquet	218
BIC® J23 Briquet	222
BIC® J26 Briquet	226
BIC® J38 Briquet	230
BIC® EZ Reach™ Briquet	234

### AUTRES PRODUITS

Cendrier de poche BIC®	244
------------------------	-----

### BRIQUETS DJEEP®

Briquet DJEEP® D1	248
-------------------	-----

### ÉTUIS POUR BRIQUETS BIC®

BIC® Styl'it Luxury Étui	238
BIC® Aluminium Flat Étui	240
BIC® Clip Étui	241
BIC® 3D Étui	242

---

## EMBALLAGES BIC® 254

Emballage Primaire BIC® Ecolutions®	258	Emballage Secondaire BIC®	264
Emballage Primaire BIC®	258		

---

## INFORMATIONS GÉNÉRALES 266

Commandez en toute simplicité !	270	Index des produits	278
Symboles et abréviations	272	Nuancier de Couleurs	279
Paramètres techniques pour chaque type d'impression	277		

# Bienvenue dans l'univers du BIC...

Depuis 1944, notre Groupe BIC apporte de la joie grâce à la simplicité, faisant de BIC une icône mondiale, aimée dans le monde entier.

— Comptant avec la confiance de millions de personnes, chaque jour.



*Des produits  
iconiques que tout  
le monde aime.*

*Pour tous !*

*Des solutions  
d'impression créatives  
et avancées.*

*Pour les  
professionnels !*



## ...et dans le monde de BIC Graphic !

Nous allons au-delà des produits décorés :  
nous célébrons 30 ans à concevoir des  
histoires de marque qui durent vraiment.

— Des produits iconiques aux solutions créatives.

# C'est pourquoi nous vous invitons à : **Créer** avec nous.

Concevons ensemble des  
solutions créatives pour rendre votre  
marque encore plus remarquable.



Nous allions créativité, technologies  
d'impression avancées et expertise  
technique pour concevoir des solutions qui  
se distinguent, inspirent et créent des liens.

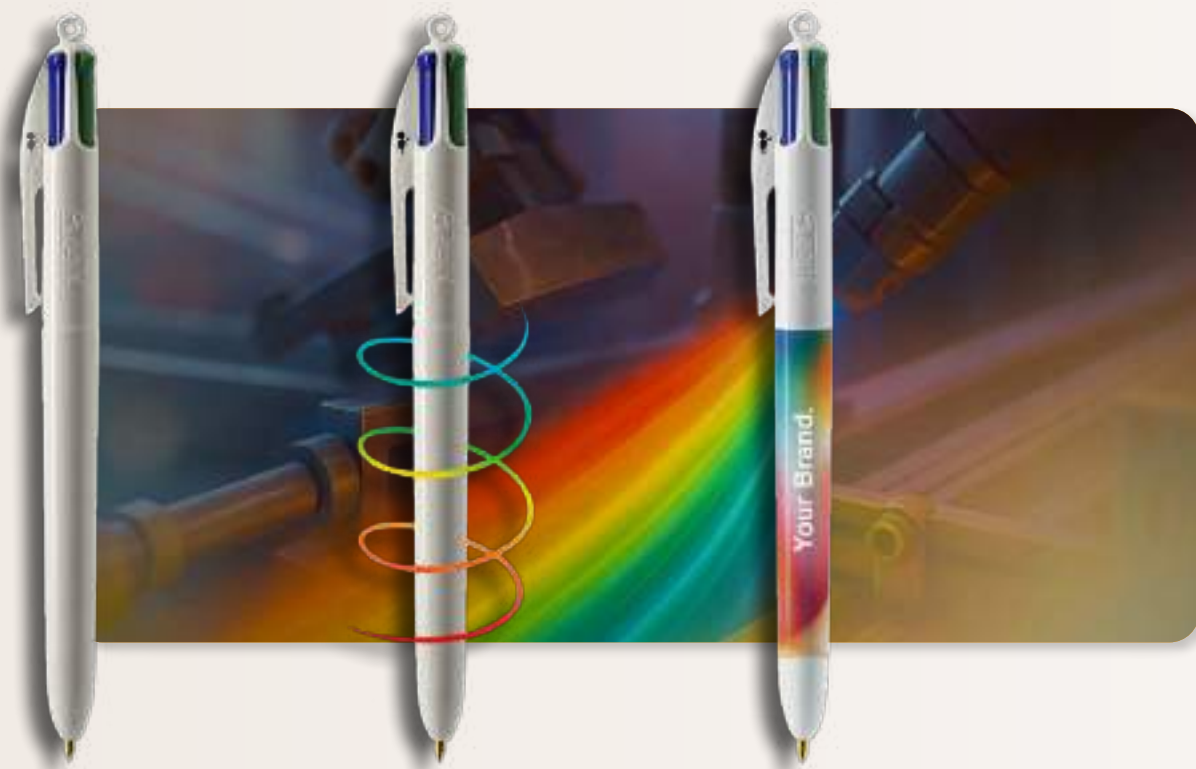

Personnalisez!



Design 360°

"Créer avec nous"  
signifie aussi créer avec...

# UNE ICÔNE



Et  
innovation

- ✓ Des produits iconiques réinventés avec de nouvelles possibilités.
- ✓ Des capacités créatives et technologiques : impression avancée, design, personnalisation.



“Créer avec nous”  
signifie aussi créer avec...

## CONNEXION

- ✓ Une véritable proximité avec nos clients : fabrication en Europe, service client dans leur langue, équipes commerciales locales.
- ✓ Les produits BIC® accompagnent chaque étape de la vie.
- ✓ Une connexion émotionnelle et culturelle avec chaque marché.



Chez BIC Graphic, nous mettons votre marque dans le meilleur emplacement au monde : **dans la vie des gens.**

*Chaque jour !*



"Créer avec nous"  
signifie aussi créer avec...

# CONFIANCE

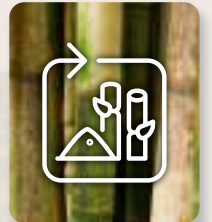

- ✓ Conception de produits durables : longue durée de vie, matériaux minimaux.
- ✓ Production et décoration locales, alimentées à 100 % par des énergies renouvelables.
- ✓ Qualité certifiée et fabrication responsable.

# Créons un meilleur avenir



# Personnalisons chaque produit de manière responsable.



## FABRIQUÉ EN EUROPE

En gardant la production proche de nos clients, nous réduisons les distances de transport, minimisons les émissions et maintenons un contrôle total sur l'ensemble de la chaîne de valeur.



# CONÇU POUR DURER

+3,000  
allumages



Des produits durables que l'on utilise plus longtemps, ce qui contribue à réduire les déchets et la consommation de ressources au fil du temps, avec un impact durable.



## INNOVATION DURABLE

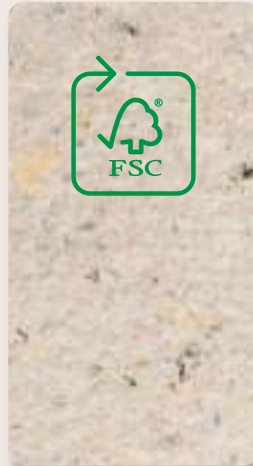

*Matériau recyclé!*

Nos installations privilégient l'utilisation de matériaux alternatifs et durables, et fonctionnent avec de l'électricité issue à 100 % d'énergies renouvelables.





## L'ÉDUCATION COMPTE

Grâce à la Fondation d'entreprise BIC, plus de 210 millions d'enfants ont bénéficié de nos initiatives en faveur de l'éducation.

Notre objectif : donner les moyens à 250 millions de jeunes apprenants dans le monde entier.

*Opportunités et impact social !*

## → NOS CERTIFICATIONS



ecovadis



United Nations Global Compact



Sedex Member



## Que signifie ce symbole ?



**Le symbole Möbius indique la teneur en matières recyclées du produit.**

Le pourcentage indiqué à l'intérieur du symbole précise la quantité exacte de plastique recyclé utilisé. Une ligne de texte sous le symbole indique la base de calcul utilisée pour déterminer le pourcentage en poids.

## Simple. Clair. Transparent.

Chez BIC®, nous transformons les déchets quotidiens en nouvelles possibilités, des pièces automobiles aux pots de yaourt et aux barquettes de fruits.



Pièces automobiles en plastique



Réfrigérateurs et pots de yaourt



Cageots de fruits et légumes



Déchets pharmaceutiques

### Par exemple :

Notre **BIC® Media Clic Ecolutions® Plus** est composé à **98 % de plastique recyclé** dans ses parties externes.

**ecolutions®**



FABRIQUÉ À PARTIR DE **98% DE MATÉRIEL RECYCLÉ\***

\*Hors système d'encre



PIÈCES AUTOMOBILES EN PLASTIQUE

*RECHERCHEZ  
LE SYMBOLE DANS  
TOUT LE CATALOGUE  
ET DÉCOUVREZ QUELS PRODUITS  
CONTRIBUENT DÉJÀ À RÉDUIRE L'IMPACT  
ENVIRONNEMENTAL.*



# PRODUITS DURABLES



Fabriqué à partir de déchets plastiques provenant de pièces automobiles.

- BIC® MEDIA CLIC GRIP ECOLUTIONS®**
- BIC® MEDIA CLIC ECOLUTIONS®**
- BIC® MEDIA CLIC ECOLUTIONS® PLUS**
- BIC® SUPER CLIP ECOLUTIONS®**
- BIC® 4 COULEURS® ECO**

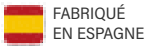

Fabriqué à partir de sucre de canne.

- BIC® MEDIA CLIC BIOBASED ECOLUTIONS®**

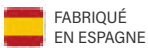

Fabriqué à partir de matériaux biosourcés.

- BIC® SUPER CLIP ORIGIN**

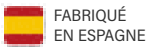

FSC et carton recyclable.

- SPROUT™ CRAYON GRAPHITE**

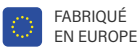

Fabriqué à partir de réfrigérateurs et de pots de yaourt recyclés

- BIC® EVOLUTION® ECOLUTIONS®**



- BIC® KIDS EVOLUTION® ECOLUTIONS® COLOURING SET**



Fabriqué à partir de déchets pharmaceutiques

- BIC® PERMANENT MARKER ECOLUTIONS®**



Fabriqué à partir de cageots de fruits et légumes

- BIC® WIDE BODY™ ECOLUTIONS®**
- BIC® CLIC STIC ECOLUTIONS®**
- BIC® ROUND STIC® ECOLUTIONS®**



BIC GRAPHIC

INSTRUMENTS D'ÉCRITURE BIC®

AUTRES INSTRUMENTS D'ÉCRITURE

CARNETS

BRIQUETS BIC®/DJEEP® ET ÉTIUIS BIC®

EMBALLAGES BIC®

INFORMATIONS GÉNÉRALES

## Des produits recyclés pour vos idées créatives !

Une situation de victoire absolue : pour la planète et pour vos projets. Les **BIC® Media Clic Ecolutions® Plus** et **BIC® Kids Evolution® Colouring Set** sont conçus avec des matériaux recyclés, du papier certifié FSC et des emballages durables. Avec **Ecolutions®**, le choix responsable est aussi le plus pratique et le plus créatif.

PRODUITS DURABLES FABRIQUÉS À PARTIR DE MATÉRIAU RECYCLÉ



RÉFRIGÉRATEURS ET POTS DE YAOURT



PIÈCES AUTOMOBILES EN PLASTIQUE

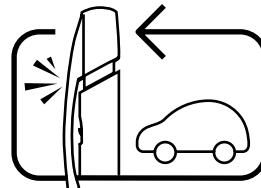

**Clip incassable,** désormais fabriqué à partir de matériaux recyclés.

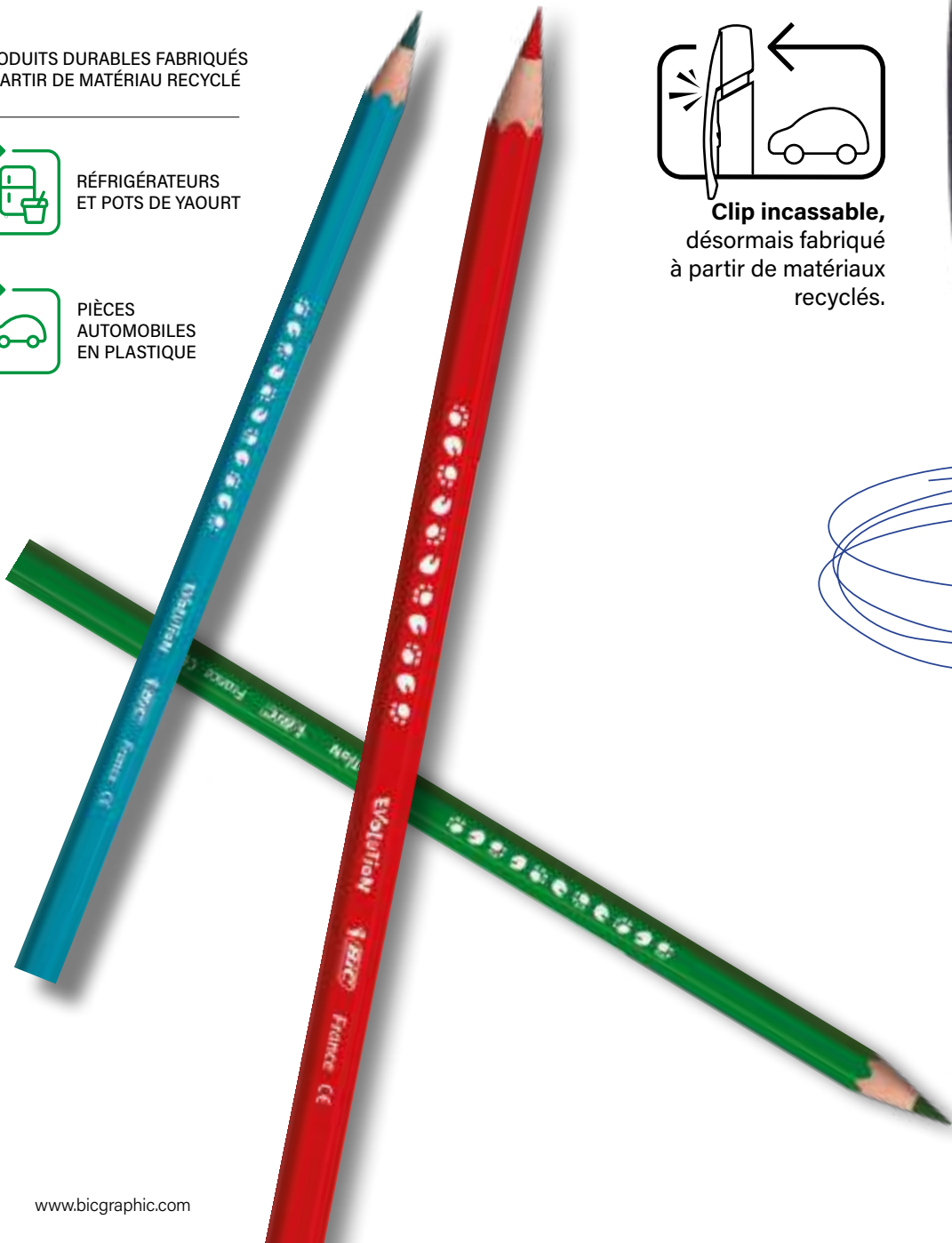



NOUVEAU !

BIC® Kids Evolution® Colouring Set  
12 unités

BIC® Kids Evolution® Colouring Set  
6 unités



NOUVEAU !

BIC® Media Clic  
Evolutions® Plus

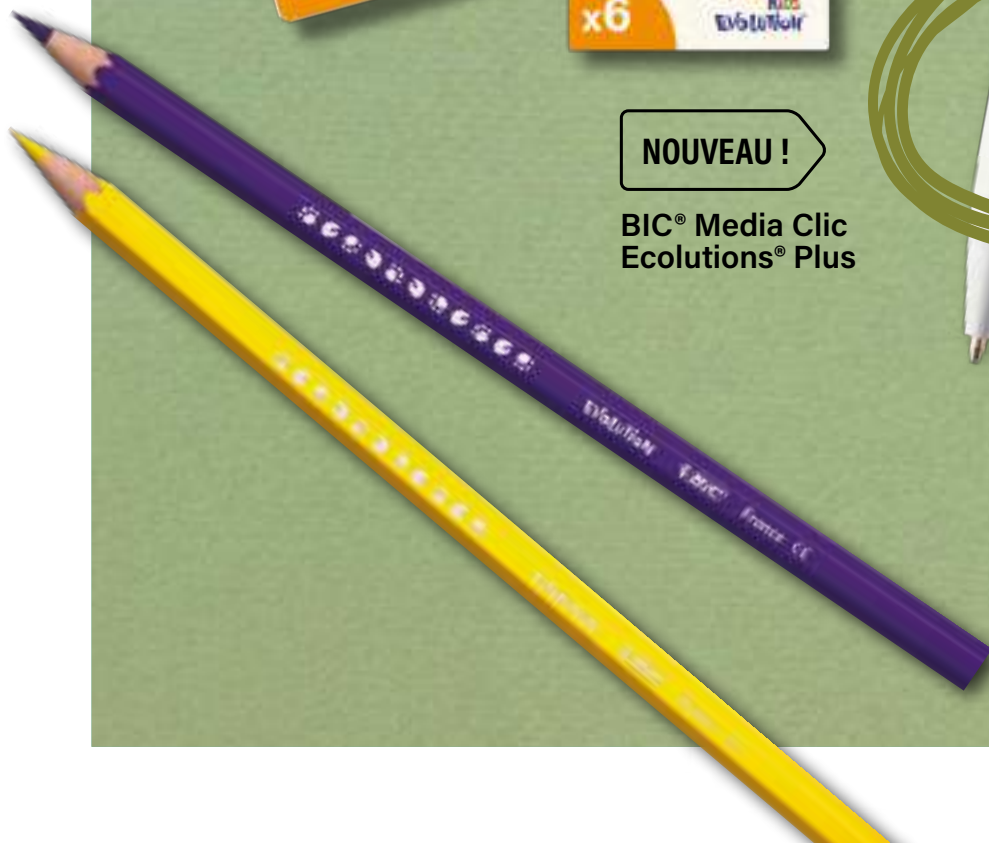

BIC  
GRAPHIC

INSTRUMENTS  
D'ÉCRITURE BIC®

AUTRES INSTRUMENTS  
D'ÉCRITURE

CARNETS

BRIQUETS BIC®/DJEOP®  
ET ÉTUIS BIC®

EMBALLAGES  
BIC®

INFORMATIONS  
GÉNÉRALES

# Le moteur iconique du changement.

Les grands changements commencent par des étapes incroyables. Le premier **BIC® 4 Couleurs® ECO**, dont le corps est fabriqué à partir de 98 % de plastique recyclé provenant de pièces automobiles recyclées\*, en est un exemple. Mais ce n'est que le début, car vous écrirez le prochain chapitre du changement durable.

Laissez votre marque avec le nouveau BIC® 4 Couleurs® ECO.

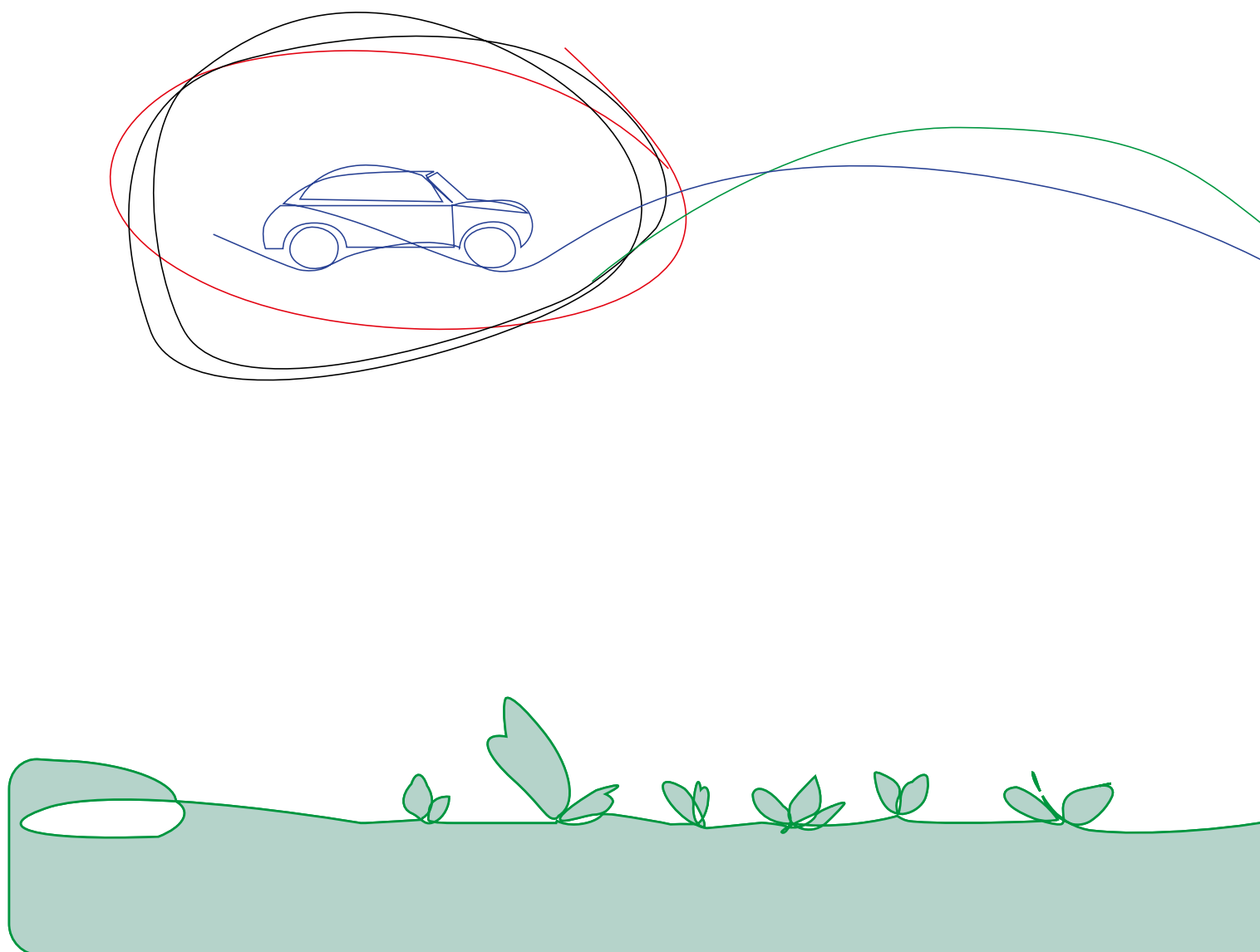



**NOUVEAU !**

**BIC® 4 Couleurs® ECO**



**Fabriqué à partir de 98 % de  
plastique recyclé provenant de  
pièces automobiles\*.**

Corps



\* Le pourcentage est calculé sur la base du poids total du corps. En raison du contenu recyclé des matières premières avec lesquelles le produit est fabriqué, nous ne pouvons pas garantir que les couleurs qui apparaissent dans le catalogue, ni les couleurs personnalisées à la carte, aient toujours la même couleur et la même apparence.

# Un style qui séduit



Une évolution raffinée de notre classique best-seller. Désormais doté d'une section argentée, d'un système d'encre rechargeable et d'innombrables possibilités de personnalisation. *Parce que votre marque mérite un stylo aussi élégant qu'intelligent.*

**NOUVEAU !**

BIC® Media Clic Advance



Rechargeable



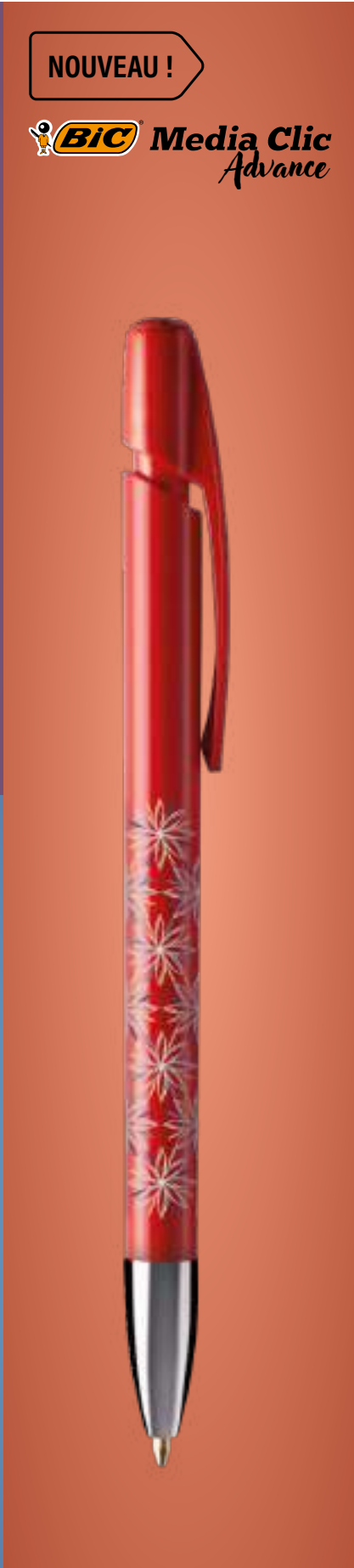

# Chic. Audacieux. Intemporel.

Améliorez votre écriture avec le **BIC® Cristal® Re'New™ Black**, le stylo classique revisité avec une finition noire brillante et élégante. Chic, confortable et conçu pour durer, ce stylo à bille rechargeable haut de gamme est un choix plus durable.

NOUVEAU !

BIC® Cristal®  
Re'New™  
Black



Écrivez en noir  
ou en bleu !  
Toujours  
à la mode.

## Corps noir métallique élégant:

Finition moderne et brillante pour un look sophistiqué.

## Conception rechargeable:

Comprend une cartouche d'encre noire dans le stylo et 1 recharge d'encre bleue supplémentaire pour une utilisation prolongée.

**Parfait pour toutes les occasions:** Écriture professionnelle, cadeaux ou style quotidien.



## Forme hexagonale emblématique:

Prise en main confortable et contrôlée pour une écriture fluide.

## Durable et écologique:

Rechargeable pour une utilisation continue, réduisant ainsi les déchets.

**Conçu pour être fiable.  
Testé pendant 70 ans.**



*Ensemble, nous célébrons  
les 70 ans du stylo à bille  
BIC® M10® Clic.*

NOUVEAU !

BIC® M10® Clic Pastel

# Vintage, tendance, pastel !

FABRIQUÉ EN FRANCE

# Conçu pour mettre les idées **EN VALEUR**

Idéal pour l'expression créative, les cadeaux d'entreprise,  
les évènements et les promotions éducatives.

Précis et éclatant, il met votre marque en avant.

Grande surface plane idéale pour l'impression numérique BritePix™ en couleur.



**WOW!**



ENCRE À BASE D'EAU  
(JUSQU'À 95 % D'ORIGINE NATURELLE).

COULEURS  
FLUORESCENTES  
VIVES

VOTRE MARQUE  
SUR LE CORPS

DOUBLE POINTE  
1,2 MM POUR SOULIGNER  
ET 4,6 MM POUR SURLIGNER

SÉCHAGE RAPIDE



# INSTRUMENTS D'ÉCRITURE BIC®

---

# 01

## Découvrez la nouvelle génération de stylos BIC® Cristal®.

Le BIC® Cristal® Expression allie un design intemporel à une personnalisation BritePix™ éclatante. Le **BIC® Cristal® Re'New™** se caractérise par un corps métallique argenté mat durable et un capuchon en plastique recyclé à 96 %, tandis que le **BIC® Cristal® Re'New™ Black** ajoute une finition brillante et sophistiquée à l'emblématique **BIC® Cristal® Re'New™**.

Écrit jusqu'à 3 Km



**1095**  
BIC® Cristal®  
Expression



**1095**  
BIC® Cristal®  
Expression



**1095**  
BIC® Cristal®  
Expression



**1095**  
BIC® Cristal®  
Expression



**1090**  
BIC® Cristal®  
Re'New™



**1092**  
BIC® Cristal®  
Re'New™ Black



# Objet emblématique du design.

1095

BIC® CRISTAL®  
EXPRESSION

1095

Couleur d'encre



02



03



05



04

échelle 1:1

1095

**BIC® CRISTAL® EXPRESSION**

1095

A BP: BritePix™ Digital

Commande minimale 250 u.

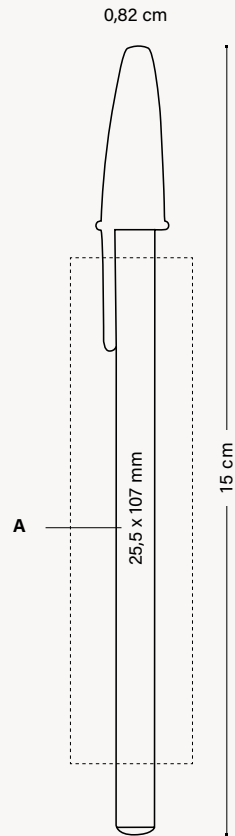

#### EMBALLAGE SPÉCIAL EN OPTION



BIC® COLLECTION BOX  
SLIM PENS 4 UNITÉS

+ INFO PAGES 254 À 265

#### EMBALLAGE EXTERNE



500 ± 3,5 KG



FABRIQUÉ ET  
IMPRIMÉ DANS  
LES USINES BIC



RESPECTANT  
LES NORMES



FABRIQUÉ  
EN FRANCE



ISO  
certified

MODES  
D'ÉCRITURE



BILLE M  
Ø 1 MM

TECHNIQUES  
D'IMPRESSION



BRITEPIX™ DIGITAL

DURABILITÉ



IMPRIM'VERT®



RECHARGEABLE



REGARDEZ LA VIDEO

# L'élégance vêtue de métal.

1090

BIC® CRISTAL®  
RE'NEW™

1090

Couleur d'encre



18

18

18

échelle 1:1

BIC® WINDOW BOX

1 STYLO + 2 CARTOUCHES



*Votre Cristal® Re'New™ avec  
toujours le même coffret-cadeau !*

(Inclus dans le prix)

1090

**BIC® CRISTAL® RE'NEW™**

1090

A LE: max. 1 coul.

Commande minimale 25 u.

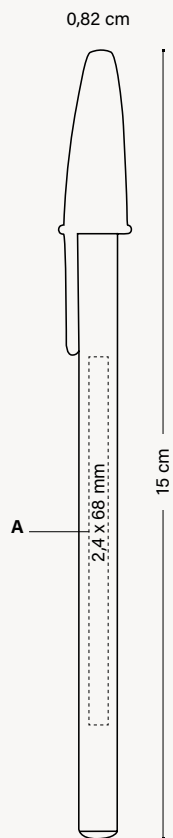

## EMBALLAGE EXTERNE



MODES D'ÉCRITURE



TECHNIQUES D'IMPRESSION



DURABILITÉ



BIC GRAPHIC

INSTRUMENTS D'ÉCRITURE BIC®

AUTRES INSTRUMENTS D'ÉCRITURE

CARNETS

BRIQUETS BIC®/DJEEP® ET ÉTUIS BIC®

EMBALLAGES BIC®

INFORMATIONS GÉNÉRALES

# Élégant. Raffiné. Rechargeable.

1092

**BIC® CRISTAL®  
RE'NEW™ BLACK**  
1092

Couleur d'encre



18



18

**NOUVEAU !**

**BIC® WINDOW BOX**

*1 STYLO À ENCRE NOIRE + 1 CARTOUCHE BLEUE*



*Votre BIC® Cristal® Re'New™ Black  
est livré dans cet emballage !*

(Inclus dans le prix)

# BIC® CRISTAL® RE'NEW™ BLACK

1092

**BIC® CRISTAL® RE'NEW™ BLACK**  
1092

A LE: max. 1 coul.

Commande minimale 25 u.

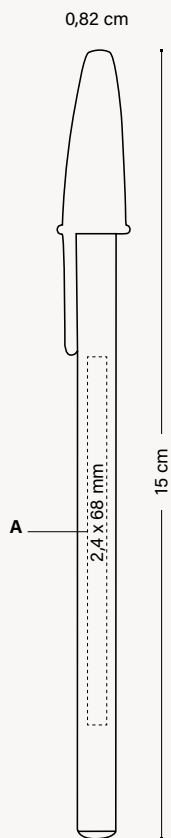

## EMBALLAGE EXTERNE



MODES  
D'ÉCRITURE



TECHNIQUES  
D'IMPRESSION



DURABILITÉ



BIC  
GRAPHIC

INSTRUMENTS  
D'ÉCRITURE BIC®

AUTRES INSTRUMENTS  
D'ÉCRITURE

CARNETS

BRIQUETS BIC®/DJEEP®  
ET ÉTUIS BIC®

EMBALLAGES  
BIC®

INFORMATIONS  
GÉNÉRALES

Consultez les pages 272-276 pour une explication détaillée des icônes.

BIC® STYLE

**Facilement  
reconnaissable dans  
le monde entier grâce  
à son capuchon  
emblématique.**

Le BIC® Style offre un excellent  
rapport qualité-prix.

*Simple et reconnaissable.*

*Un style classique*



1610

**BIC® STYLE**  
1610 Opaque

Couleur d'encre



01/01

01/03

01/04

01/02

02/02

04

10

échelle 1:1

●  
Disponible avec  
encre noire  
uniquement

●  
Disponible avec  
encre bleue  
uniquement

●  
Disponible avec  
encre noire  
uniquement



MODES  
D'ÉCRITURE



TECHNIQUES  
D'IMPRESSION



DURABILITÉ



100 % DE L'ÉLECTRICITÉ  
PROVIENT DE SOURCES  
RENOUVELABLES

Consultez les pages 272, 276 pour une explication détaillée des icônes.

1610

**BIC® STYLE**  
1610 Transparent

Couleur d'encre



1610

**BIC® STYLE**

1610 Opaque  
**A SP:** max. 1 coul.

**BIC® STYLE**

1610 Transparent  
**B SP:** max. 1 coul.

Commande minimale 500 u.

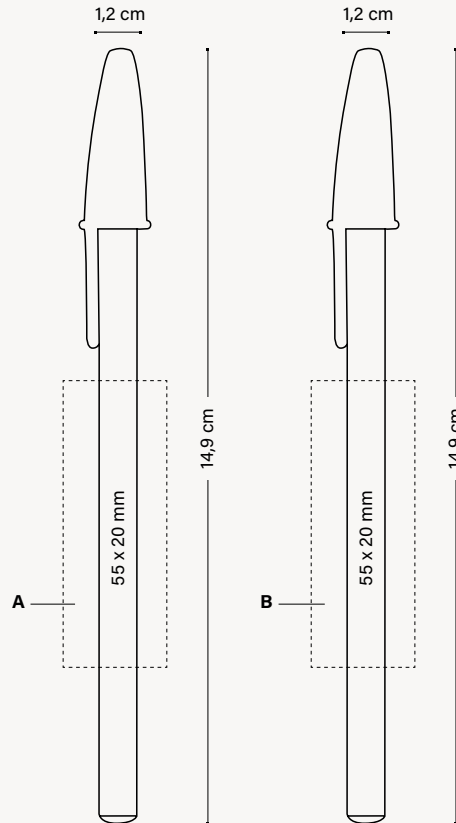

**MODES D'ÉCRITURE**



**TECHNIQUES D'IMPRESSON**



**DURABILITÉ**



**EMBALLAGE SPÉCIAL EN OPTION**



BIC® COLLECTION BOX SLIM PENS 4 UNITÉS

+ INFO PAGES 254 À 265

**EMBALLAGE EXTERNE**



Peut être utilisé comme marque-page

BIC® ROUND STIC®

**Le BIC® Round Stic®  
offre un design  
intemporel, une  
écriture fluide et  
une grande qualité.**

Écrire devient  
un plaisir



1010

**BIC® ROUND STIC®**  
1010 Opaque

Couleur d'encre  
● ● ●

Encre rouge disponible sur demande



L'iconique BIC® Boy et le logo BIC® en relief !



Disponible en corps blanc



MODES D'ÉCRITURE



TECHNIQUES D'IMPRESSION



DURABILITÉ



1010

**BIC® ROUND STIC®**

1010 Givré

Couleur d'encre



*Encre rouge disponible sur demande*



69



63



71



66



68



67



the company

40

échelle 1:1

# BIC® ROUND STIC®

Version ECO.  
Au même prix que la version standard !

**ecolutions®**



FABRIQUÉ À PARTIR DE **98%**  
**DE MATÉRIEL RECYCLÉ\***  
\*Hors système d'encre

CAGEOTS  
DE FRUITS  
ET LÉGUMES



1E10

**BIC® ROUND STIC®**  
1E10 Opaque

Couleur d'encre  
● ● ●

Encre rouge disponible sur demande



1E/6E

1E/7E

1E/10E

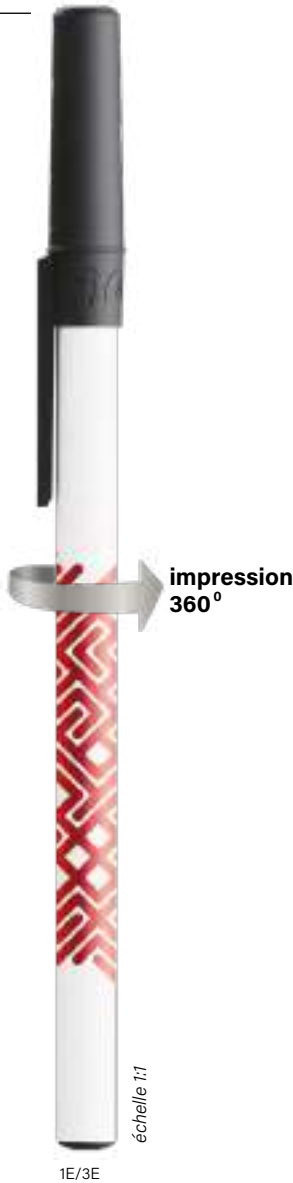

échelle 1:1

Disponible en  
corps blanc



1E10

**BIC® ROUND STIC®**  
1E10 Givré

Couleur d'encre  
● ● ●

Encre rouge disponible  
sur demande



2E/6E

2E/7E

2E/3E

2E/10E

échelle 1:1

**MIX & MATCH**



COULEURS  
PERSONNALISÉES



FABRIQUÉ ET  
IMPRIMÉ DANS  
LES USINES BIC



FABRIQUÉ EN  
ESPAGNE



RESPECTANT  
LES NORMES



MODES  
D'ÉCRITURE



BILLE M  
Ø 1 MM

TECHNIQUES  
D'IMPRESSION



SÉRIGRAPHIE



DIGITAL

DURABILITÉ



**ecolutions®**



CAGEOTS  
DE FRUITS  
ET LÉGUMES



100 % DE L'ÉLECTRICITÉ  
PROVIENT DE SOURCES  
RENOUVELABLES

BIC  
GRAPHIC

INSTRUMENTS  
D'ÉCRITURE BIC®

AUTRES INSTRUMENTS  
D'ÉCRITURE

CARNETS

BRIQUETS BIC®/DJEEP®  
ET ÉTUIS BIC®

EMBALLAGES  
BIC®

INFORMATIONS  
GÉNÉRALES

Consultez les pages 272-276 pour une explication détaillée des icônes.

\*Pourcentage calculé sur le poids total du produit cartouche exclue. En raison du contenu recyclé des matières premières avec lesquelles le produit est fabriqué, nous ne pouvons pas garantir que les couleurs qui apparaissent dans le catalogue, ni les couleurs personnalisées à la carte, aient toujours la même couleur et la même apparence.

# BIC® ROUND STIC®

1010 / 1E10

## BIC® ROUND STIC®

1010 / **ecolutions®** 1E10 Opaque

1010 / **ecolutions®** 1E10 Givré

Commande minimale 500 u.

Combinaison de couleurs standards

**MIX & MATCH**

Sans frais supplémentaires

**ecolutions®**

CAGEOTS DE FRUITS ET LÉGUMES

Combinaison de couleurs standards\*

### Bouton

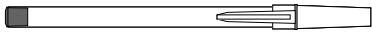

Opaque

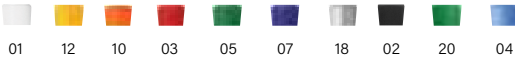

Givré

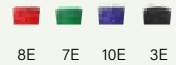

### Capuchon

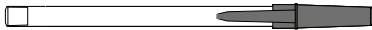

Opaque

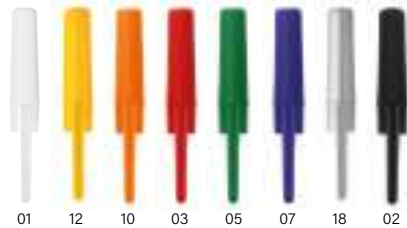

Givré

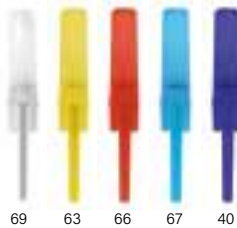

### Section

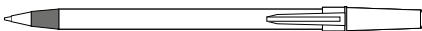

Opaque

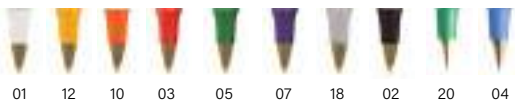

Givré

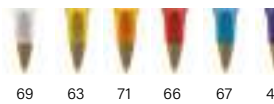

### Corps



Opaque

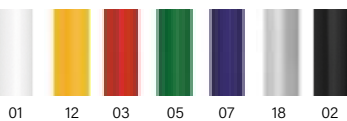

Givré

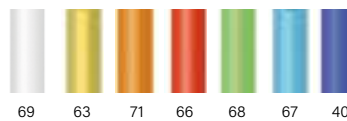

Injection d'une couleur spéciale: ≥ 10.000 unités



\*Hors système d'encre.

Ajoutez la boucle mobius sur votre BAT sans frais additionnels. Merci de le préciser dans votre bon de commande (en bas à gauche par défaut)

1010 / 1E10

## BIC® ROUND STIC®

1010

ecolutions® 1E10

A SP: max. 3 coul.

B SP: max. 1 coul.

C SP: max. 1 coul.

D DG: Numérique

(uniquement disponible en corps blanc)

Commande minimale 500 u.

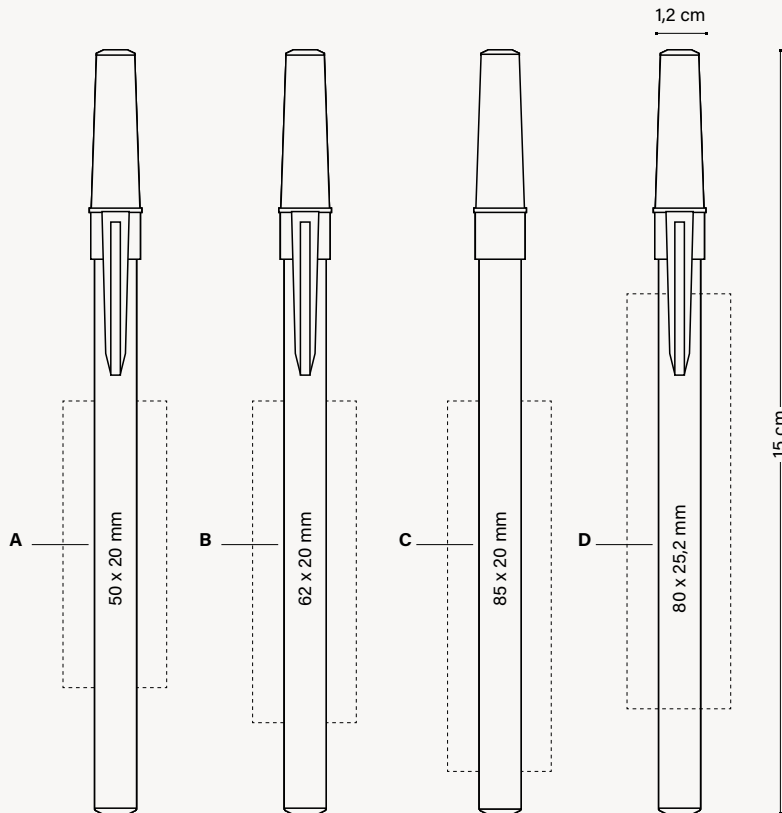

### EMBALLAGE SPÉCIAL EN OPTION



PLASTIC  
POUCH



BIC® COLLECTION BOX  
SLIM PENS 4 UNITÉS

+ INFO PAGES 254 À 265

### EMBALLAGE EXTERNE



500 ± 2,5 KG

Peut être  
utilisé comme  
marque-page

MIX &  
MATCH



COULEURS  
PERSONNALISÉES



FABRIQUÉ ET  
IMPRIMÉ DANS  
LES USINES BIC



FABRIQUÉ EN  
ESPAGNE



RESPECTANT  
LES NORMES



MODES  
D'ÉCRITURE



BILLE M  
Ø 1 MM

TECHNIQUES  
D'IMPRESSION



SP  
SÉRIGRAPHIE



DG  
DIGITAL

DURABILITÉ



IMPRIM'VERT®

ecolutions®



CAGEOTS  
DE FRUITS  
ET LÉGUMES



100 % DE L'ÉLECTRICITÉ  
PROVIENT DE SOURCES  
RENOUVELABLES

BIC  
GRAPHIC

INSTRUMENTS  
D'ÉCRITURE BIC®

AUTRES INSTRUMENTS  
D'ÉCRITURE

CARNETS

BRIQUETS BIC®/DJEEP®  
ET ÉTUIS BIC®

EMBALLAGES  
BIC®

INFORMATIONS  
GÉNÉRALES

Consultez les pages 272-276 pour une explication détaillée des icônes.

BIC® M10® CLIC

# Conçu pour être fiable. Testé pendant 70 ans



L'iconique BIC® Boy et le logo BIC® en relief !

1590

BIC® M10® CLIC  
1590

Couleur d'encre



NOUVEAU !

BIC® M10® CLIC PASTEL

MADE IN FRANCE

Bouton-poussoir latéral



échelle 1:1

●  
Disponible avec encre noire uniquement

1590

**BIC® M10® CLIC**  
1590

A SP: max. 2 coul.

Commande minimale 500 u.

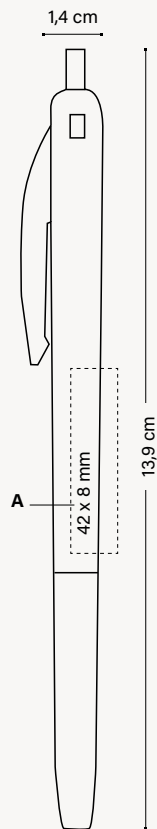

### EMBALLAGE SPÉCIAL EN OPTION



PLASTIC  
POUCH



WINDOW  
BOX

+ INFO PAGES 254 À 265

*Peut être  
utilisé comme  
marque-page*

### EMBALLAGE EXTERNE



500 ± 4,1 KG



MODES  
D'ÉCRITURE



TECHNIQUES  
D'IMPRESSION



DURABILITÉ



REGARDEZ LA VIDEO



## Notre BIC® Media Clic, un best-seller de l'industrie.

Au design fonctionnel et largement reconnu, c'est un produit durable disponible dans différents matériaux. Choisissez parmi le Standard, Recyclé, Biobased, Antibactérien et finitions premium.

Laissez-vous inspirer par la vaste gamme de finitions et de couleurs, et associez-les pour mettre en valeur votre marque."

# FAMILLE BIC® MEDIA CLIC



**1035**  
BIC® Media Clic  
Advance



**1025**  
BIC® Media Clic  
Opaque



**1025**  
BIC® Media Clic Givré



**1E25**  
BIC® Media Clic  
Ecolutions®



**1E29**  
BIC® Media Clic  
Ecolutions® Plus



**1020**  
BIC® Media Clic  
Grip Givré



**1E20**  
BIC® Media Clic  
Grip Ecolutions®



**1026**  
BIC® Media Clic BGuard™  
Antibacterial



**1E26**  
BIC® Media Clic BGuard™  
Antimicrobial Ecolutions®



**1972**  
BIC® Media Clic Biobased  
Ecolutions®



**1973**  
BIC® Media Clic Biobased  
BGuard™ Antibacterial



**1975**  
BIC® Media Clic Shine



**1930**  
BIC® Media Clic Glacé

BIC  
GRAPHIC

INSTRUMENTS  
D'ÉCRITURE BIC®

AUTRES INSTRUMENTS  
D'ÉCRITURE

CARNETS

BRIQUETS BIC®/DJEEP®  
ET ÉTUIS BIC®

EMBALLAGES  
BIC®

INFORMATIONS  
GÉNÉRALES

1035

## BIC® MEDIA CLIC ADVANCE

1035 Stylo  
Opaque

Couleur d'encre



NOUVEAU !

Section  
en métal !



35



01 / 35



03 / 35



07 / 35



06 / 35



02 / 35



Service de  
recharge sur  
demande

échelle 1:1

1035

## BIC® MEDIA CLIC ADVANCE

1035 Style

A SP: max. 4 coul.

B SP: max. 2 coul.

Commande minimale 500 u.

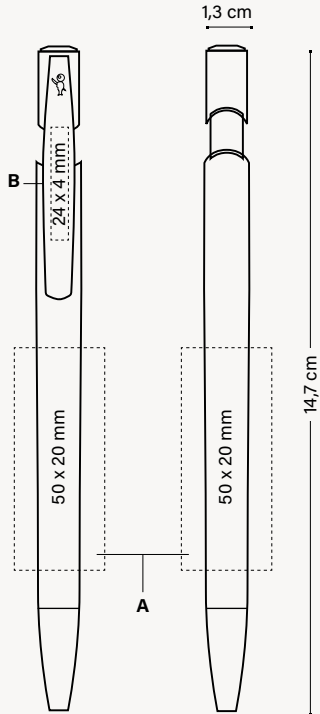

### EMBALLAGE SPÉCIAL EN OPTION



ECO SLEEVE

+ INFO PAGES 254 À 265



PLASTIC POUCH



WINDOW BOX

*Peut être  
utilisé comme  
marque-page*

### EMBALLAGE EXTERNE



500 ± 6,5 KG

## Bouton

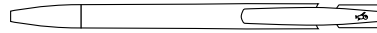

Opaque

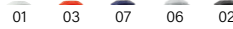

## Clip

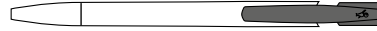

Opaque



## Corps



Opaque

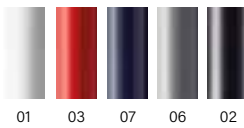

## Section



Silver

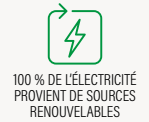

BIC GRAPHIC

INSTRUMENTS D'ÉCRITURE BIC®

AUTRES INSTRUMENTS D'ÉCRITURE

CARNETS

BRIQUETS BIC®/DJEEP® ET ÉTUIS BIC®

EMBALLAGES BIC®

INFORMATIONS GÉNÉRALES

1025



L'iconique  
BIC® Boy  
en relief!



Disponible  
aussi en version  
porte-mines

## BIC® MEDIA CLIC

1025 Stylo / 1028 Porte-mines (consultez la page 172)

Opaque

Couleur d'encre



Encre rouge disponible sur demande



Version ECO.  
Au même prix que la version standard !

**ecolutions®**



FABRIQUÉ À PARTIR DE **98%**  
**DE MATÉRIEL RECYCLÉ\***

\*Hors système d'encre



PIÈCES AUTOMOBILES  
EN PLASTIQUE

1E25

**BIC® MEDIA CLIC**

1E25 Stylo

Opaque

Couleur d'encre



impression  
360°

échelle 1:1

échelle 1:1

**MIX & MATCH**



COULEURS  
PERSONNALISÉES



FABRIQUÉ ET  
IMPRIMÉ DANS  
LES USINES BIC



FABRIQUÉ EN  
ESPAGNE



RESPECTANT  
LES NORMES



ISO  
certified

MODES  
D'ÉCRITURE



BILLE M  
Ø 1 MM

TECHNIQUES  
D'IMPRESSION



SP  
SÉRIGRAPHIE



DG  
DIGITAL

DURABILITÉ



IMPRIM'VERT®

**ecolutions®**



PIÈCES  
AUTOMOBILES  
EN PLASTIQUE



100 % DE L'ÉLECTRICITÉ  
PROVIENT DE SOURCES  
RENOUVELABLES

BIC  
GRAPHIC

INSTRUMENTS  
D'ÉCRITURE BIC®

AUTRES INSTRUMENTS  
D'ÉCRITURE

CARNETS

BRIQUETS BIC®/DJEEP®  
ET ÉTUIS BIC®

EMBALLAGES  
BIC®

INFORMATIONS  
GÉNÉRALES

\*Pourcentage calculé sur le poids total du produit cartouche exclue. En raison du contenu recyclé des matières premières avec lesquelles le produit est fabriqué, nous ne pouvons pas garantir que les couleurs qui apparaissent dans le catalogue, ni les couleurs personnalisées à la carte, aient toujours la même couleur et la même apparence.

BIC® MEDIA CLIC ECOLUTIONS® PLUS

**98% recyclé\***

\*Toutes les parties externes sont fabriquées à partir de 98% de matériaux recyclés, grâce au nouveau clip.

Clip incassable,  
désormais  
fabriqué à partir de  
matériaux recyclés.

98% recyclé\*



# BIC® MEDIA CLIC ECOLUTIONS® PLUS

Version ECO.  
Au même prix que la version standard !



**98% DE MATÉRIEL RECYCLÉ\***

FABRIQUÉ À PARTIR DE **98% DE MATÉRIEL RECYCLÉ\***

\*Hors système d'encre

PIÈCES AUTOMOBILES EN PLASTIQUE



1E29

**BIC® MEDIA CLIC ECOLUTIONS® PLUS**

1E29

Opaque

Couleur d'encre



Encre rouge disponible sur demande



1E

3E

1E

3E

échelle 1:1

**MIX & MATCH**



**MODES D'ÉCRITURE**



**TECHNIQUES D'IMPRESSION**



**DURABILITÉ**



**ecolutions®**



BIC GRAPHIC

INSTRUMENTS D'ÉCRITURE BIC®

AUTRES INSTRUMENTS D'ÉCRITURE

CARNETS

BRIQUETS BIC® / DJEEP® ET ÉTUIS BIC®

EMBALLAGES BIC®

INFORMATIONS GÉNÉRALES

\*Pourcentage calculé sur le poids total du produit cartouche exclue. En raison du contenu recyclé des matières premières avec lesquelles le produit est fabriqué, nous ne pouvons pas garantir que les couleurs qui apparaissent dans le catalogue, ni les couleurs personnalisées à la carte, aient toujours la même couleur et la même apparence.

1025



L'icône  
BIC® Boy  
en relief!



Disponible  
aussi en version  
porte-mines

## BIC® MEDIA CLIC

1025 Stylo / 1028 Porte-mines (consultez la page 172)

Givré

Couleur d'encre



Encre rouge disponible sur demande



1020 / 1021

L'icône  
BIC® Boy  
en relief!

Disponible  
aussi en version  
porte-mines

## BIC® MEDIA CLIC GRIP

1020 Stylo

1021 Porte-mines (consultez la page 173)

Givré

Couleur d'encre



01/69



71/69



82/69



40/69

échelle 1:1

MIX &  
MATCH



COULEURS  
PERSONNALISÉES



FABRIQUÉ ET  
IMPRIMÉ DANS  
LES USINES BIC



FABRIQUÉ EN  
ESPAGNE



RESPECTANT  
LES NORMES



MODES  
D'ÉCRITURE



BILLE M  
Ø 1 MM

TECHNIQUES  
D'IMPRESSION



SÉRIGRAPHIE



DIGITAL

DURABILITÉ



IMPRIM'VERT®



100 % DE L'ÉLECTRICITÉ  
PROVIENT DE SOURCES  
RENOUVELABLES

BIC  
GRAPHIC

INSTRUMENTS  
D'ÉCRITURE BIC®

AUTRES INSTRUMENTS  
D'ÉCRITURE

CARNETS

BRIQUETS BIC®/DJEEP®  
ET ÉTUIS BIC®

EMBALLAGES  
BIC®

INFORMATIONS  
GÉNÉRALES

Consultez les pages 272-276 pour une explication détaillée des icônes.

**MIX & MATCH**



COULEURS PERSONNALISÉES



FABRIQUÉ ET IMPRIMÉ DANS LES USINES BIC



FABRIQUÉ EN ESPAGNE



RESPECTANT LES NORMES



MODES D'ÉCRITURE



BILLE M Ø 1 MM

TECHNIQUES D'IMPRESSION



SÉRIGRAPHIE



DIGITAL

DURABILITÉ



IMPRIM'VERT®

ecolutions®



PIÈCES AUTOMOBILES EN PLASTIQUE



100 % DE L'ÉLECTRICITÉ PROVIENT DE SOURCES RENOUVELABLES



L'iconique BIC® Boy en relief !



Disponible aussi en version porte-mines

Version ECO. Au même prix que la version standard !

ecolutions®



FABRIQUÉ À PARTIR DE 98% DE MATÉRIEL RECYCLÉ\*  
\*Hors système d'encre



PIÈCES AUTOMOBILES EN PLASTIQUE

1E20 / 1E21

**BIC® MEDIA CLIC GRIP**

1E20 Stylo

1E21 Porte-mines (consultez la page 175)

Opaque

Couleur d'encre



01/03



01/05



01/02



01/07

échelle 1:1

\*Pourcentage calculé sur le poids total du produit cartouche exclue. En raison du contenu recyclé des matières premières avec lesquelles le produit est fabriqué, nous ne pouvons pas garantir que les couleurs qui apparaissent dans le catalogue, ni les couleurs personnalisées à la carte, aient toujours la même couleur et la même apparence.

**MIX & MATCH** Sans frais supplémentaires

Commande minimale 500 u.  
eColutions® Combinaison de couleurs standards

## Bouton



Opaque 01 12 10 03 5C 2D 13 5G 05 3D 04 07 18 02

Givré 69

## Clip

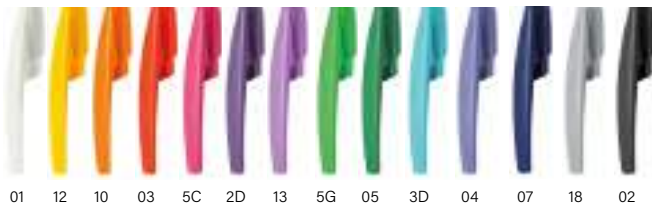
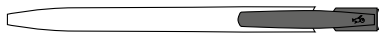

Opaque 69

## Corps



Opaque 01 12 10 03 5C 2D 13 5G 05 3D 04 07 3C 18 02

Givré 69 63 71 66 68 82 67 40 4B

## Corps et Grip

01/69 71/69 82/69 40/69

Injection d'une couleur spéciale: ≥ 10.000 unités 1025/1E25  
Injection d'une couleur spéciale: ≥ 20.000 unités 1020/1E20



**eColutions®**



PIÈCES AUTOMOBILES EN PLASTIQUE

Combinaison de couleurs standards\*

Opaque



Corps et Grip Opaque

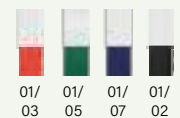

\*Hors système d'encre

Ajoutez la boucle mobius sur votre BAT sans frais additionnels. Merci de le préciser dans votre bon de commande (en bas à gauche par défaut)

**MIX & MATCH**  
eColutions®

COULEURS PERSONNALISÉES  
FABRIQUÉ ET IMPRIMÉ DANS LES USINES BIC

TECHNIQUES D'IMPRESSION

SP SÉRIGRAPHIE  
DG DIGITAL

MODES D'ÉCRITURE

BILLE M  
Ø 1 MM

DURABILITÉ

PIÈCES AUTOMOBILES EN PLASTIQUE

\*En raison du contenu recyclé des matières premières avec lesquelles le produit est fabriqué, nous ne pouvons pas garantir que les couleurs qui apparaissent dans le catalogue, ni les couleurs personnalisées à la carte, aient toujours la même couleur et la même apparence.

1025 / 1028 / 1E25 / 1E29

**BIC® MEDIA CLIC**

1025 Stylo  
 1028 Porte-mines (*consultez la page 172*)  
 1E25 Stylo **ecolutions®**  
 1E29 Stylo **ecolutions® Plus**

**A SP:** max. 4 coul.  
**B SP:** max. 2 coul.  
**C DG:** Numérique

Commande minimale 500 u.

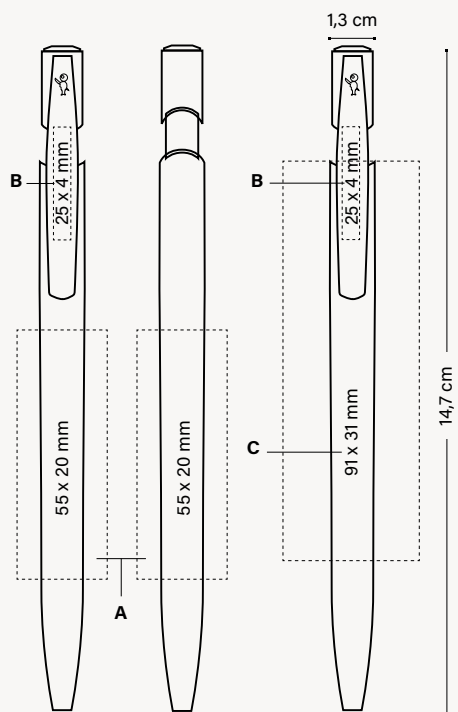

**EMBALLAGE SPÉCIAL EN OPTION**

**EMBALLAGE EXTERNE**



ECO SLEEVE



PLASTIC POUCH



WINDOW BOX



500 ± 4,1 KG

+ INFO PAGES 254 À 265

*Peut être utilisé comme marque-page*



**TECHNIQUES D'IMPRESION**

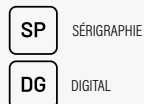

**MODES D'ÉCRITURE**



**DURABILITÉ**



## 1020 / 1E20 / 1021 / 1E21

### BIC® MEDIA CLIC GRIP

1020 Stylo  
1021 Porte-mines  
(consultez la page 173)

D SP: max. 4 coul.

E SP: max. 2 coul.

F DG: Numérique

Commande minimale 500 u.

### ecolutions® 1E20 Stylo

ecolutions® 1E21 Porte-mines  
(consultez la page 173)

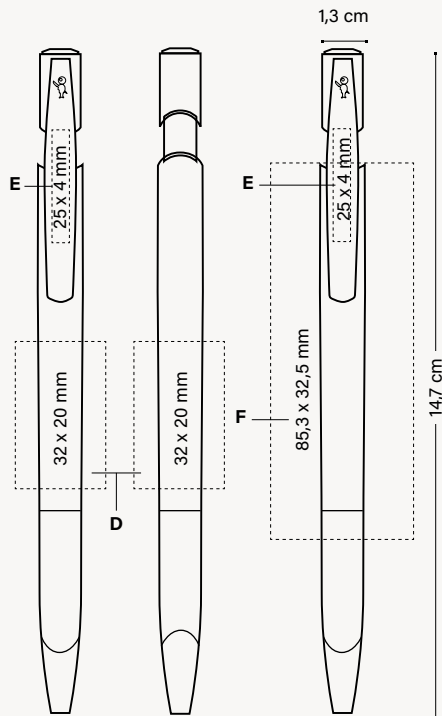

### EMBALLAGE SPÉCIAL EN OPTION



ECO SLEEVE

+ INFO PAGES 254 À 265



PLASTIC POUCH

Peut être  
utilisé comme  
marque-page



WINDOW BOX

### EMBALLAGE EXTERNE



500 ± 4,3 KG



FABRIQUÉ ET  
IMPRIMÉ DANS  
LES USINES BIC

FABRIQUÉ  
EN ESPAGNE

### TECHNIQUES D'IMPRESSION

SP SÉRIGRAPHIE

DG DIGITAL

### MODES D'ÉCRITURE

BILLE M  
Ø 1 MM

### DURABILITÉ

PIÈCES  
AUTOMOBILES  
EN PLASTIQUE

# BIC® MEDIA CLIC BGUARD™ ANTIBACTÉRIEN

BGUARD™



Protection contre les bactéries



Protection sur toute la surface du stylo



Protection à vie

ISO 22196

Testé selon un protocole antibactérien

1026

## BIC® MEDIA CLIC BGUARD™ ANTIBACTERIAL

1026: logo antibactérien

Opaque

Couleur d'encre



Encre rouge disponible sur demande



MIX & MATCH

Sans frais supplémentaires

Commande minimale 500 u.  
Combinaison de couleurs standards

### Bouton



Opaque 1BG 2BG

### Clip



Opaque 1BG 2BG

### Corps



Opaque 1BG 2BG

Injection d'une couleur spéciale: ≥ 10.000 unités



L'iconique BIC® Boy et le logo antibactérien toujours visibles !

ANTIBACTERIAL™

# BIC® MEDIA CLIC BGUARD™ ANTIBACTÉRIEN

1026

## BIC® MEDIA CLIC BGUARD™ ANTIBACTERIAL

1026: logo antibactérien

A SP: max. 2 coul.

B SP: max. 1 coul.

Commande minimale 500 u.

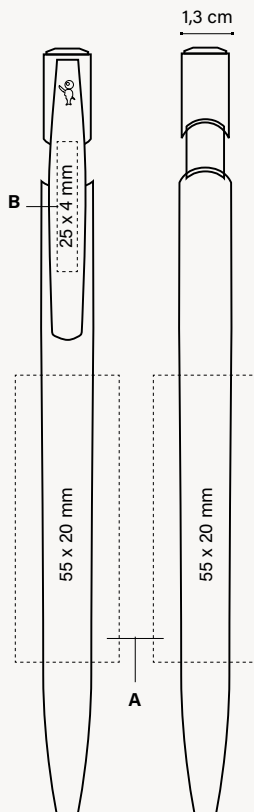

### EMBALLAGE SPÉCIAL EN OPTION



ECO SLEEVE

+ INFO PAGES 254 À 265



PLASTIC POUCH



WINDOW BOX

*Peut être  
utilisé comme  
marque-page*

### EMBALLAGE EXTERNE



500 ± 4,1 KG

MIX &  
MATCH



COULEURS  
PERSONNALISÉES



FABRIQUÉ ET  
IMPRIMÉ DANS  
LES USINES BIC



FABRIQUÉ  
EN ESPAGNE



RESPECTANT  
LES NORMES



ISO  
certified

MODES  
D'ÉCRITURE



BILLE M  
Ø 1 MM

TECHNIQUES  
D'IMPRESSION



SP  
SÉRIGRAPHIE

DURABILITÉ



IMPRIM'VERT®



100 % DE L'ÉLECTRICITÉ  
PROVIENT DE SOURCES  
RENOUVELABLES

BIC  
GRAPHIC

INSTRUMENTS  
D'ÉCRITURE BIC®

AUTRES INSTRUMENTS  
D'ÉCRITURE

CARNETS





BRIQUETS BIC®/DJEEP®  
ET ÉTUIS BIC®

EMBALLAGES  
BIC®

INFORMATIONS  
GÉNÉRALES

Consultez les pages 272-276 pour une explication détaillée des icônes.

# BIC® MEDIA CLIC BGUARD™ ANTIMICROBIAL ECOLUTIONS®

 **ANTIMICROBIAL™\*** = 
  99,9 % de protection contre les bactéries en 24 h + 
  93 % de réduction virale en 24 h + 
  Inhibition des champignons 24 h

BGUARD™

ecolutions®



FABRIQUÉ À PARTIR DE **98% DE MATÉRIEL RECYCLÉ\***

\*Hors système d'encre

PIÈCES AUTOMOBILES EN PLASTIQUE



1E26

## BIC® MEDIA CLIC BGUARD™ ANTIMICROBIAL ECOLUTIONS®

ecolutions® 1E26: logo antimicrobial Opaque

Couleur d'encre



Encre rouge disponible sur demande



**MIX & MATCH** Sans frais supplémentaires



Ajoutez la boucle mobius sur votre BAT sans frais additionnels. Merci de préciser dans votre bon de commande (en bas à gauche par défaut)

Commande minimale 500 u.  
Combinaison de couleurs standards

### Bouton

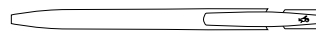

Opaque 1BG 2BG

### Clip

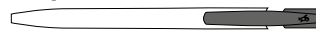

Opaque 1BG 2BG

### Corps



Opaque 1E 3E

Injection d'une couleur spéciale: > 10.000 unités



\*99,9 % des bactéries sont éliminées de la surface en 24 h (et plus de 30 % en 2 heures)

Testé selon le protocole ISO 22196 adapté à l'usage réel du stylo

93 % des virus, notamment le Sars-Cov-2 coronavirus qui provoque le Covid-19, sont éliminés de la surface en 24 heures (et environ 50 % en 2 heures).

Testé selon le protocole ISO 22196 adapté à l'usage réel du stylo

Les moisissures présentes sur la surface sont inhibées en 24 heures.

Testé selon le protocole ISO 22196 adapté aux moisissures et à l'usage réel du stylo

Vous pouvez également faire imprimer le logo anti-SARS-CoV-2. N'hésitez pas à vous renseigner auprès de votre service client !

\*\* Pourcentage calculé sur le poids total du produit cartouche exclue. En raison du contenu recyclé des matières premières avec lesquelles le produit est fabriqué, nous ne pouvons pas garantir que les couleurs qui apparaissent dans le catalogue, ni les couleurs personnalisées à la carte, aient toujours la même couleur et la même apparence.

# BIC® MEDIA CLIC Bguard™ ANTIMICROBIAL ECOLUTIONS®



Protection de la surface du stylo



Protection à vie

ISO 22196

Testé selon un protocole antibactérien

ISO 22196

Adapté au protocole de test antifongique

ISO 22702

Protocole de test antiviral

1E26

## BIC® MEDIA CLIC Bguard™ ANTIMICROBIAL ECOLUTIONS®

ecolutions® 1E26: logo antimicrobial

A SP: max. 2 coul.

B SP: max. 2 coul.

Commande minimale 500 u.

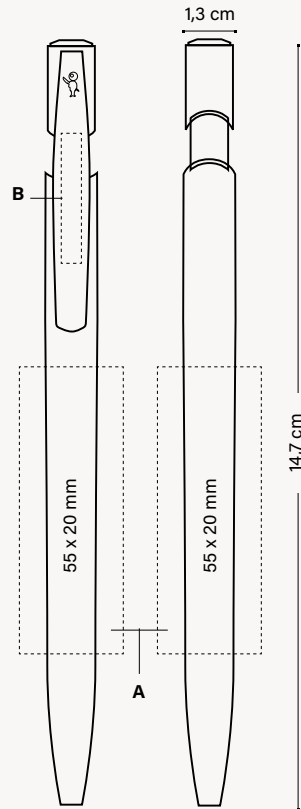

### EMBALLAGE SPÉCIAL EN OPTION



ECO SLEEVE  
+ INFO PAGES 254 À 265



PLASTIC POUCH



WINDOW BOX



500 ± 41 KG

Peut être utilisé comme marque-page

### EMBALLAGE EXTERNE

MIX & MATCH



COULEURS PERSONNALISÉES



FABRIQUÉ ET IMPRIMÉ DANS LES USINES BIC



FABRIQUÉ EN ESPAGNE



RESPECTANT LES NORMES



ISO certified

MODES D'ÉCRITURE



BILLE M  
Ø 1 MM

TECHNIQUES D'IMPRESSION



SÉRIGRAPHIE

DURABILITÉ



IMPRIM'VERT®

ecolutions®



PIÈCES AUTOMOBILES EN PLASTIQUE



100 % DE L'ÉLECTRICITÉ PROVIENT DE SOURCES RENOUVELABLES

BIC GRAPHIC

INSTRUMENTS D'ÉCRITURE BIC®

AUTRES INSTRUMENTS D'ÉCRITURE

CARNETS

BRIQUETS BIC®/DJEEP® ET ÉTUIS BIC®

EMBALLAGES BIC®

INFORMATIONS GÉNÉRALES

Consultez les pages 272, 276 pour une explication détaillée des icônes.

## BIOBASED ecolutions®

FABRIQUÉ À PARTIR DE  
69 % DE MATÉRIAUX BIOSOURCÉS\*

MIX & MATCH



COULEURS  
PERSONNALISÉES



FABRIQUÉ ET  
IMPRIMÉ DANS  
LES USINES BIC



FABRIQUÉ EN ESPAGNE



RESPECTANT  
LES NORMES



MODES  
D'ÉCRITURE



BILLE M  
0.1 MM

TECHNIQUES  
D'IMPRESSION



SÉRIGRAPHIE



DIGITAL

DURABILITÉ



IMPRIM'VERT®

ecolutions®



CANNE  
À SUCRE



100 % DE L'ÉLECTRICITÉ  
PROVIENT DE SOURCES  
RENOUVELABLES

### 1972

#### BIC® MEDIA CLIC BIOBASED ECOLUTIONS®

1972 Stylo

Opaque

Couleur d'encre



Encre rouge disponible sur demande



14A

4M

9C

12BIO

03BIO

04BIO

02BIO

05BIO

01BIO

échelle 1:1

Disponible en  
corps blanc

britePix  
DIGITAL

\* Pourcentage calculé à partir du poids total du corps du stylo, matériaux biosourcés dans des conditions industrielles. En raison du contenu naturel des matières premières avec lesquelles le produit est fabriqué, nous ne pouvons pas garantir que les couleurs qui apparaissent dans le catalogue, ni les couleurs personnalisées à la carte, aient toujours la même couleur et la même apparence.

# BIC® MEDIA CLIC BIOBASED ECOLUTIONS®



**MIX & MATCH** Sans frais supplémentaires

Commande minimale 500 u.  
Combinaison de couleurs standards

## Bouton

Opaque 01 12 10 03 5C 2D 13 84 5G 05 3D 04 07 18 02 Givré 69

## Clip

Opaque 01 12 10 03 5C 2D 13 5G 05 3D 04 07 18 02 Givré 69

## Corps

Opaque

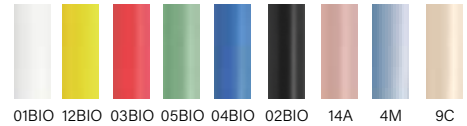

Injection d'une couleur spéciale:  
≥ 10.000 unités.

1972

## BIC® MEDIA CLIC BIOBASED ECOLUTIONS®

1972

**A SP:** max. 2 coul.

**B SP:** max. 2 coul.

**C DG:** Numérique

Commande minimale 500 u..

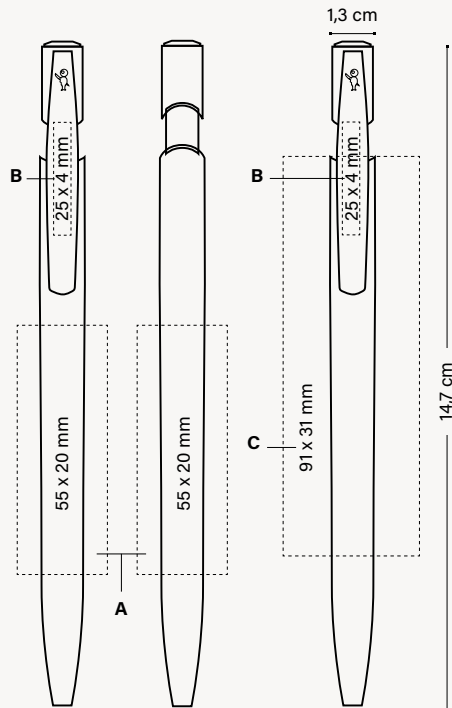

### EMBALLAGE SPÉCIAL EN OPTION



+ INFO PAGES 254 À 265



Peut être utilisé comme marque-page



### EMBALLAGE EXTERNE



MODES D'ÉCRITURE



TECHNIQUES D'IMPRESSION



DURABILITÉ



BIC GRAPHIC

INSTRUMENTS D'ÉCRITURE BIC®

AUTRES INSTRUMENTS D'ÉCRITURE

CARNETS

BRIQUETS BIC®/DJEEP® ET ÉTUIS BIC®

EMBALLAGES BIC®

INFORMATIONS GÉNÉRALES

\* En raison du contenu naturel des matières premières avec lesquelles le produit est fabriqué, nous ne pouvons pas garantir que les couleurs qui apparaissent dans le catalogue, ni les couleurs personnalisées à la carte, aient toujours la même couleur et la même apparence.

# BIC® MEDIA CLIC BIOBASED BGUARD™ ANTIBACTERIAL

MIX & MATCH



COULEURS PERSONNALISÉES



FABRIQUÉ ET IMPRIMÉ DANS LES USINES BIC



FABRIQUÉ EN ESPAGNE



RESPECTANT LES NORMES



MODES D'ÉCRITURE



BILLE M  
Ø 1 MM

TECHNIQUES D'IMPRESSION



SÉRIGRAPHIE

DURABILITÉ



IMPRIM'VERT®



SUCRE DE CANNE



100 % DE L'ÉLECTRICITÉ PROVIENT DE SOURCES RENOUVELABLES

BGUARD™



Protection contre les bactéries



Protection de la surface du stylo



Protection à vie

ISO 22196

Testé selon un protocole antibactérien

**BIOBASED** ecolutions®

FABRIQUÉ À PARTIR DE 69 % DE MATÉRIAUX BIOSOURCÉS\*

1973

**BIC® MEDIA CLIC BIOBASED BGUARD™ ANTIBACTERIAL**

1973 Stylo

Opaque

Couleur d'encre



Encre rouge disponible sur demande



02

01

échelle 1:1

\*Pourcentage calculé à partir du poids total du corps du stylo, matériaux biosourcés dans des conditions industrielles. En raison du contenu naturel des matières premières avec lesquelles le produit est fabriqué, nous ne pouvons pas garantir que les couleurs qui apparaissent dans le catalogue, ni les couleurs personnalisées à la carte, aient toujours la même couleur et la même apparence.

# BIC® MEDIA CLIC BIOBASED BGUARD™ ANTIBACTERIAL



SUCRE DE CANNE

**MIX & MATCH** Sans frais supplémentaires

Commande minimale 500 u. Combinaison de couleurs standards.

## Bouton



Opaque

01BG 02BG

## Clip



Opaque



01BG 02BG

## Corps



Opaque

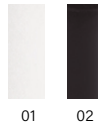

01 02

Injection d'une couleur spéciale: ≥ 10.000 unités.



1973

### BIC® MEDIA CLIC BIOBASED BGUARD™ ANTIBACTÉRIEN

1973

A SP: max. 2 coul.

B SP: max. 2 coul.

Commande minimale 500 u.

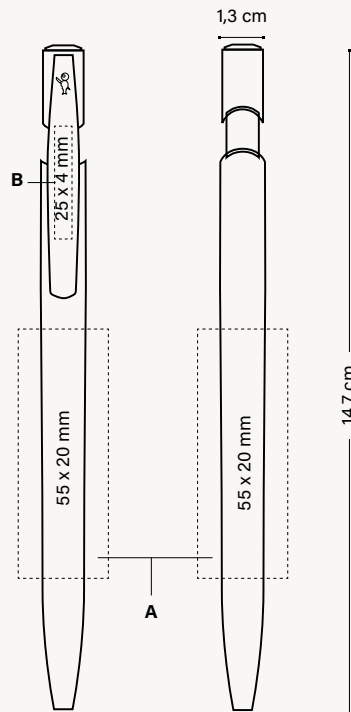

#### EMBALLAGE SPÉCIAL EN OPTION



+ INFO PAGES 254 À 265

Peut être utilisé comme marque-page

#### EMBALLAGE EXTERNE



COULEURS PERSONNALISÉES



FABRIQUÉ ET IMPRIMÉ DANS LES USINES BIC



FABRIQUÉ EN ESPAGNE

MODES D'ÉCRITURE



BILLE M Ø 1 MM

TECHNIQUES D'IMPRESSION



SÉRIGRAPHIE

DURABILITÉ



SUCRE DE CANNE

BIC GRAPHIC

INSTRUMENTS D'ÉCRITURE BIC®

AUTRES INSTRUMENTS D'ÉCRITURE

CARNETS

BRIQUETS BIC® / DJEEP® ET ÉTUIS BIC®

EMBALLAGES BIC®

INFORMATIONS GÉNÉRALES

Consultez les pages 272-276 pour une explication détaillée des icônes.

\*En raison du contenu naturel des matières premières avec lesquelles le produit est fabriqué, nous ne pouvons pas garantir que les couleurs qui apparaissent dans le catalogue, ni les couleurs personnalisées à la carte, aient toujours la même couleur et la même apparence.

1975

**BIC® MEDIA CLIC SHINE**  
1975 Stylo

Couleur d'encre



*Encre rouge disponible sur demande*



47



26

échelle 1:1

**MIX & MATCH** Sans frais supplémentaires

Commande minimale 500 u. Combinaison de couleurs standards.

## Bouton



Opaque 01 12 10 03 5C 2D 13 84 5G 05 3D 04 07 18 02 Givré 69

## Clip



Opaque 01 12 10 03 5C 2D 13 5G 05 3D 04 07 18 02 Givré 69

## Corps



Shine 26 47

1975

### BIC® MEDIA CLIC SHINE

1975

A SP: max. 2 coul.

B SP: max. 2 coul.

Commande minimale 500 u.

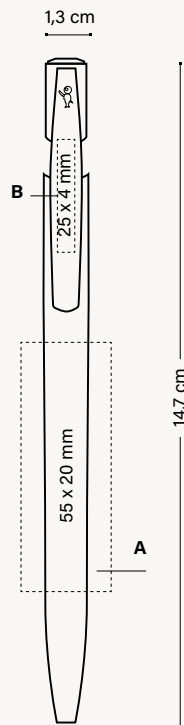

#### EMBALLAGE SPÉCIAL EN OPTION



+ INFO PAGES 254 À 265



Peut être utilisé comme marque-page



#### EMBALLAGE EXTERNE



500 ± 4,1 KG

**MIX & MATCH**

COULEURS PERSONNALISÉES

FABRIQUÉ ET IMPRIMÉ DANS LES USINES BIC

FABRIQUÉ EN ESPAGNE

RESPECTANT LES NORMES

ISO certified

MODES D'ÉCRITURE

BILLE M Ø 1 MM

TECHNIQUES D'IMPRESSION

SP SÉRIGRAPHIE

DURABILITÉ

IMPRIM'VERT\*

100 % DE L'ÉLECTRICITÉ PROVIENT DE SOURCES RENOUVELABLES

Consultez les pages 272, 276 pour une explication détaillée des icônes.

BIC® MEDIA CLIC GLACÉ

Des couleurs  
élégantes pour  
notre best-seller.

Stylo à  
bille élégant

1030

BIC® MEDIA CLIC GLACÉ

1030 Glacé

Couleur d'encre



Encre rouge disponible sur demande



échelle 1:1

# BIC® MEDIA CLIC GLACÉ

**MIX & MATCH** Sans frais supplémentaires

Commande minimale 500 u.  
Combinaison de couleurs standards

## Bouton

Opaque 01 12 10 03 5C 2D 13 84 5G 05 3D 04 07 18 02 Givré 69

## Clip

Opaque 01 12 10 03 5C 2D 13 5G 05 3D 04 07 18 02 Givré 69

## Corps

Glacé  
47G 76 03G 14G 05G 04G

1030

### BIC® MEDIA CLIC GLACÉ

1030

A SP: max. 2 coul.

B SP: max. 2 coul.

Commande minimale 500 u.

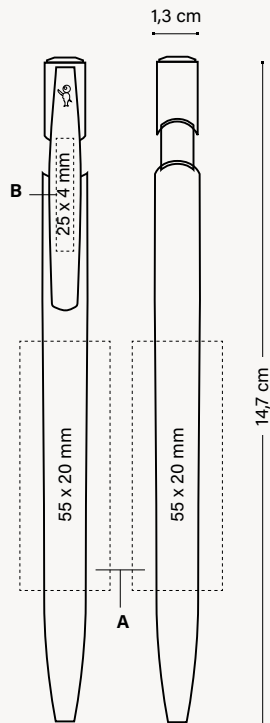

#### EMBALLAGE SPÉCIAL EN OPTION



+ INFO PAGES 254 À 265



Peut être utilisé comme marque-page



#### EMBALLAGE EXTERNE



**MIX & MATCH**

FABRIQUÉ ET IMPRIMÉ DANS LES USINES BIC

FABRIQUÉ EN ESPAGNE

RESPECTANT LES NORMES

ISO certified

MODES D'ÉCRITURE

BILLE M Ø 1 MM

TECHNIQUES D'IMPRESSION

SP SÉRIGRAPHIE

DURABILITÉ

IMPRIM'VERT®

100 % DE L'ÉLECTRICITÉ PROVIENT DE SOURCES RENOUVELABLES

BIC GRAPHIC

INSTRUMENTS D'ÉCRITURE BIC®

AUTRES INSTRUMENTS D'ÉCRITURE

CARNETS

BRIQUETS BIC®/DJEEP® ET ÉTUIS BIC®

EMBALLAGES BIC®

INFORMATIONS GÉNÉRALES

Consultez les pages 272, 276 pour une explication détaillée des icônes.

BIC® CLIC STIC

**Moderne, pratique  
et fiable !  
Le BIC® Clic Stic  
est ainsi!**

Des nombreuses  
couleurs à choisir  
et des versions  
à assembler

→  
*Des milliers de  
combinaisons de  
couleurs !*

→  
*Pointe tactile*



Version ECO.  
Au même prix que la version standard !

**ecolutions®**



FABRIQUÉ À PARTIR DE 78% DE MATÉRIEL RECYCLÉ\*

\*Hors système d'encre

CAGEOTS DE FRUITS ET LÉGUMES



**MIX & MATCH**



COULEURS PERSONNALISÉES



FABRIQUÉ ET IMPRIMÉ DANS LES USINES BIC



FABRIQUÉ EN ESPAGNE



RESPECTANT LES NORMES



MODES D'ÉCRITURE



BILLE M Ø 1 MM

TECHNIQUES D'IMPRESSION



SÉRIGRAPHIE



DIGITAL

DURABILITÉ



IMPRIM'VERT®



CAGEOTS DE FRUITS ET LÉGUMES



100 % DE L'ÉLECTRICITÉ PROVIENT DE SOURCES RENOUVELABLES

1000

**BIC® CLIC STIC**  
1000 Opaque

Couleur d'encre  
● ● ●

L'iconique BIC® Boy en relief !



impression 360°

échelle 1:1

12 05 04 07 02 03 01

Disponible en corps blanc



1E00

**BIC® CLIC STIC**  
1E00 Opaque

Couleur d'encre  
● ● ●

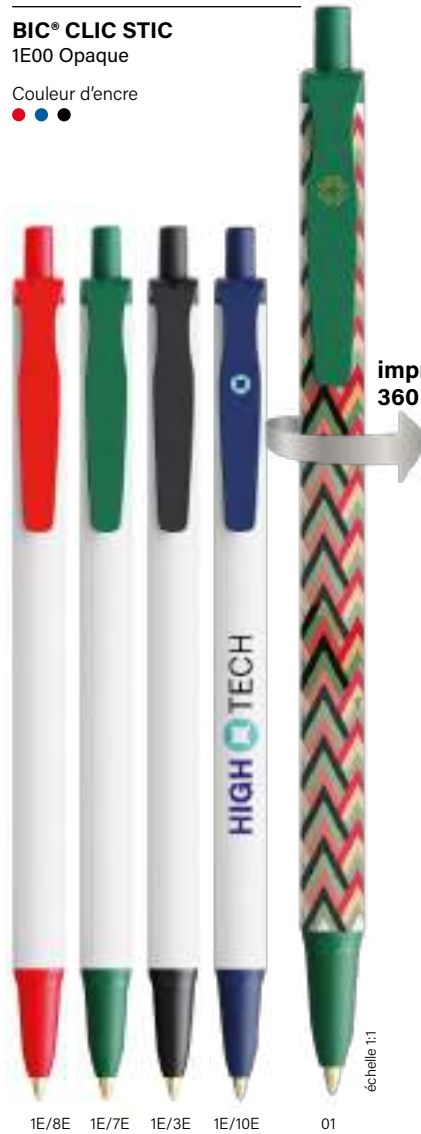

impression 360°

échelle 1:1

1E/8E 1E/7E 1E/3E 1E/10E 01

Disponible en corps blanc



\* Le pourcentage est calculé sur la base du poids total du stylo, à l'exclusion du système d'encre. En raison du contenu recyclé des matières premières avec lesquelles le produit est fabriqué, nous ne pouvons pas garantir que les couleurs qui apparaissent dans le catalogue, ni les couleurs personnalisées à la carte, aient toujours la même couleur et la même apparence.

Version ECO.  
 Au même prix que  
 la version standard !

ecolutions®



FABRIQUÉ À PARTIR  
 DE 87% DE MATÉRIEL  
 RECYCLÉ\*

\*Hors système d'encre



CAGEOTS  
 DE FRUITS  
 ET LÉGUMES

1000

BIC® CLIC STIC

1000 Givré

Couleur d'encre



Encre rouge disponible  
 sur demande



1E00

BIC® CLIC STIC

1E00 Givré

Couleur d'encre



Encre rouge disponible  
 sur demande



1005

**BIC® CLIC STIC  
SOFTFEEL®**  
1005 Opaque

Couleur d'encre



*Encre rouge disponible  
sur demande*



20



07



02

échelle 1:1

1005

**BIC® CLIC STIC  
SOFTFEEL®**  
1005 Givré

Couleur d'encre



*Encre rouge disponible sur  
demande*



40

échelle 1:1

**MIX &  
MATCH**



COULEURS  
PERSONNALISÉES



FABRIQUÉ ET  
IMPRIMÉ DANS  
LES USINES BIC



FABRIQUÉ EN ESPAGNE



RESPECTANT  
LES NORMES



**MODS  
D'ÉCRITURE**



BILLE M  
Ø 1 MM

**TECHNIQUES  
D'IMPRESSION**



SÉRIGRAPHIE



DIGITAL

**DURABILITÉ**



**ecolutions®**



CAGEOTS  
DE FRUITS  
ET LÉGUMES



100 % DE L'ÉLECTRICITÉ  
PROVIENT DE SOURCES  
RENOUVELABLES

BIC  
GRAPHIC

INSTRUMENTS  
D'ÉCRITURE BIC®

AUTRES INSTRUMENTS  
D'ÉCRITURE

CARNETS

BRIQUETS BIC®/DJEEP®  
ET ÉTUIS BIC®

EMBALLAGES  
BIC®

INFORMATIONS  
GÉNÉRALES

Consultez les pages 272-276 pour une explication détaillée des icônes.

**MIX & MATCH**



COULEURS PERSONNALISÉES



FABRIQUÉ ET IMPRIMÉ DANS LES USINES BIC



FABRIQUÉ EN ESPAGNE



RESPECTANT LES NORMES



ISO certifié

**MODES D'ÉCRITURE**



BILLE M 0.1 MM

**TECHNIQUES D'IMPRESSION**



SÉRIGRAPHIE



DIGITAL

**DURABILITÉ**



IMPRIM'VERT®



CAGEOTS DE FRUITS ET LÉGUMES



100 % DE L'ÉLECTRICITÉ PROVIENT DE SOURCES RENOUVELABLES

Version ECO.  
Au même prix que la version standard !

**ecolutions®**



FABRIQUÉ À PARTIR DE 87% DE MATÉRIEL RECYCLÉ\*

\*Hors système d'encre



CAGEOTS DE FRUITS ET LÉGUMES

1847

**BIC® CLIC STIC STYLUS**  
1847 Opaque

Couleur d'encre



Encre rouge disponible sur demande



01

03

04

02

07

échelle 1:1

1846

**BIC® CLIC STIC STYLUS**  
1846 Opaque

Couleur d'encre



Encre rouge disponible sur demande



1E

3E

échelle 1:1

\* Pourcentage calculé à partir du poids total du corps du stylo. En raison du contenu recyclé des matières premières avec lesquelles le produit est fabriqué, nous ne pouvons pas garantir que les couleurs qui apparaissent dans le catalogue, ni les couleurs personnalisées à la carte, aient toujours la même couleur et la même apparence.

Commande minimale 500 u. Combinaison de couleurs standards

## Bouton

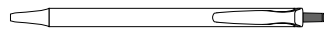

Opaque

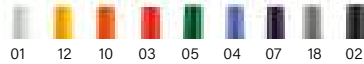

Givré

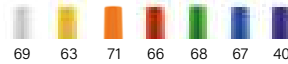

## Clip

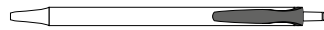

Opaque

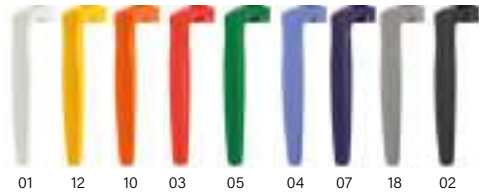

Givré

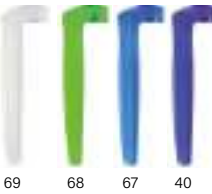

## Section

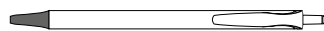

Opaque



Givré

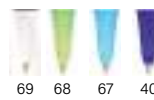

## Stylus

Opaque



## Corps



Opaque

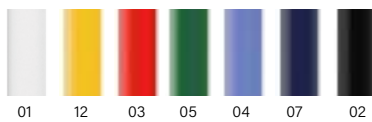

## Stylus

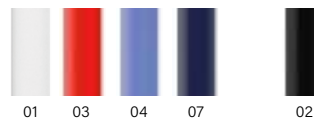

## Softfeel®

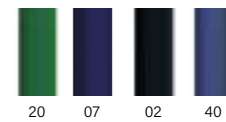

Givré

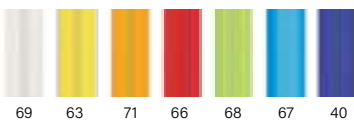

Injection d'une couleur spéciale: ≥ 10.000 unités

**ecolutions®**

Commande minimale 500 u.  
ecolutions® Combinaison  
de couleurs standards\*\*



Ajoutez la boucle mobius sur votre BAT sans frais additionnels. Merci de le préciser dans votre bon de commande (en bas à gauche par défaut)

\*Hors système d'encre



## Bouton

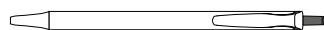

Opaque



## Section



Opaque



## Stylus

Opaque



## Clip



Opaque



## Corps



Opaque



## Stylus

Opaque



Injection d'une couleur spéciale: ≥ 10.000 unités

\*\* En raison du contenu recyclé des matières premières avec lesquelles le produit est fabriqué, nous ne pouvons pas garantir que les couleurs qui apparaissent dans le catalogue, ni les couleurs personnalisées à la carte, aient toujours la même couleur et la même apparence.



COULEURS PERSONNALISÉES



FABRIQUÉ ET IMPRIMÉ DANS LES USINES BIC



FABRIQUÉ EN ESPAGNE



RESPECTANT LES NORMES



MODES D'ÉCRITURE



BILLE M  
Ø 1 MM

TECHNIQUES D'IMPRESSION



SÉRIGRAPHIE



DIGITAL

DURABILITÉ



IMPRIM'VERT®



CAGEOTS DE FRUITS ET LÉGUMES



100 % DE L'ÉLECTRICITÉ PROVIENT DE SOURCES RENOUVELABLES

1000 / 1E00 / 1847 / 1846

## BIC® CLIC STIC

1000 / **ecolutions**® 1E00

## BIC® CLIC STIC STYLUS

1847 / **ecolutions**® 1846

**A SP:** max. 3 coul.

**B SP:** max. 1 coul.

**C SP:** max. 2 coul.

**D DG:** numérique (zone texte)

(Uniquement disponible en corps blanc)

Commande minimale 500 u.

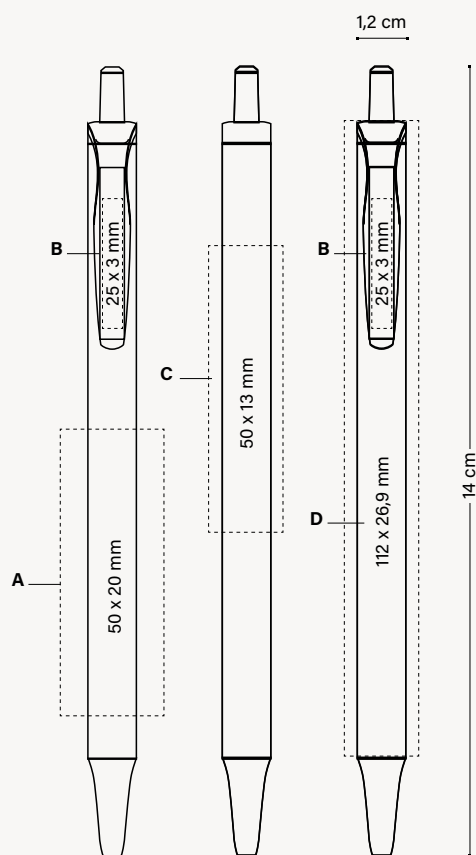

### EMBALLAGE SPÉCIAL EN OPTION



+ INFO PAGES 254 À 265



Peut être utilisé comme marque-page

### EMBALLAGE EXTERNE



500 ± 2,9 KG

1005

**BIC® CLIC STIC SOFTFEEL®**  
1005

A/B SP: max. 1 coul.

Commande minimale 500 u.

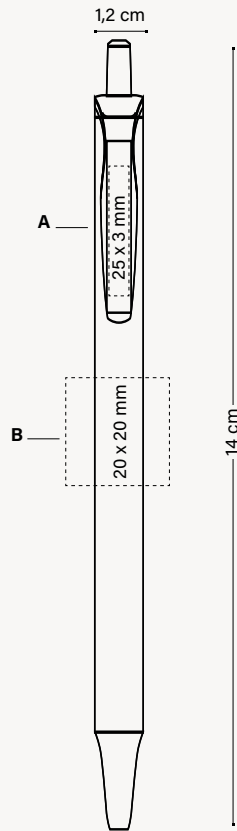

### EMBALLAGE SPÉCIAL EN OPTION



ECO SLEEVE



PLASTIC POUCH



BIC® COLLECTION BOX SLIM PENS 4 UNITÉS

+ INFO PAGES 254 À 265

*Peut être utilisé comme marque-page*

### EMBALLAGE EXTERNE



500 ± 2,9 KG

**MIX & MATCH**



COULEURS PERSONNALISÉES



FABRIQUÉ ET IMPRIMÉ DANS LES USINES BIC



FABRIQUÉ EN ESPAGNE



RESPECTANT LES NORMES



ISO certified

MODES D'ÉCRITURE



BILLE M Ø 1 MM

TECHNIQUES D'IMPRESSION



SÉRIGRAPHIE



DIGITAL

DURABILITÉ



IMPRIM'VERT®



100 % DE L'ÉLECTRICITÉ PROVIENT DE SOURCES RENOUVELABLES



Découvrez son clip Extra Large et son mécanisme pivotant très fiable.

La grande zone d'impression XXL offre une vaste gamme de possibilités de personnalisation dans la version Standard et Advance. Également dans les versions Soft et Glacé.

De plus, le BIC® Super Clip Origin est un stylo à bille plus innovant et plus durable.



**1E50**  
BIC® Super Clip Ecolutions®



**1039**  
BIC® Super Clip



**1073**  
BIC® Super Clip Advance



**1082**  
BIC® Super Clip Glacé



**1084**  
BIC® Super Clip Glacé Advance



**1083**  
BIC® Super Clip Soft



**1085**  
BIC® Super Clip Soft Advance



**1038**  
BIC® Super Clip Origin

Un grand clip à personnaliser

1039

BIC® SUPER CLIP  
1039 Opaque

Couleur d'encre  
● ●



1G 03 04 07 06 02 1P

Zone de marquage  
XXL !



Mécanisme pivotant silencieux !

impression 360°

échelle 1:1

01

Disponible en  
corps blanc



# BIC® SUPER CLIP

Version ECO.  
Au même prix que la version standard !

**ecolutions®**



FABRIQUÉ À PARTIR DE  
**90% DE MATÉRIEL  
RECYCLÉ\***

\*Hors système d'encre



PIÈCES AUTOMOBILES  
EN PLASTIQUE

1E50

**BIC® SUPER CLIP**  
1E50 Opaque

Couleur d'encre



échelle 1:1

1E

1039

**BIC® SUPER CLIP**  
1039 Transparent

Couleur d'encre



échelle 1:1

51

87

86

89

88

**MIX & MATCH**



COULEURS  
PERSONNALISÉES



FABRIQUÉ ET  
IMPRIMÉ DANS  
LES USINES BIC



FABRIQUÉ EN  
ESPAGNE



RESPECTANT  
LES NORMES



ISO  
certified

MODES  
D'ÉCRITURE



BILLE M  
Ø 1 MM

TECHNIQUES  
D'IMPRESSION



SÉRIGRAPHIE



DIGITAL



BRITEPIX™  
BRITEPIX™ TEXTURE  
BRITEPIX™ PERSONALISATION

DURABILITÉ



**ecolutions®**



PIÈCES  
AUTOMOBILES  
EN PLASTIQUE



100 % DE L'ÉLECTRICITÉ  
PROVIENT DE SOURCES  
RENOUVELABLES

BIC  
GRAPHIC

INSTRUMENTS  
D'ÉCRITURE BIC®

AUTRES INSTRUMENTS  
D'ÉCRITURE

CARNETS

BRIQUETS BIC®/DJEEP®  
ET ÉTUIS BIC®

EMBALLAGES  
BIC®

INFORMATIONS  
GÉNÉRALES

\* Pourcentage calculé sur le poids total du produit cartouche exclue. En raison du contenu recyclé des matières premières avec lesquelles le produit est fabriqué, nous ne pouvons pas garantir que les couleurs qui apparaissent dans le catalogue, ni les couleurs personnalisées à la carte, aient toujours la même couleur et la même apparence.

# BIC® SUPER CLIP

1039 / 1E50

## BIC® SUPER CLIP

1039 Opaque

ecolutions® 1E50 Opaque

1039 Transparent

Commande minimale 250 u.  
Combinaison de couleurs standards

**MIX & MATCH** Sans frais supplémentaires

### Clip



Opaque



Transparent

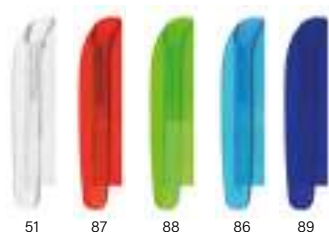

ecolutions®



Combinaison de couleurs standards\*



\*Hors système d'encre  
Ajoutez la boucle mobius sur votre BAT sans frais additionnels. Merci de le préciser dans votre bon de commande (en bas à gauche par défaut)

### Corps



Opaque

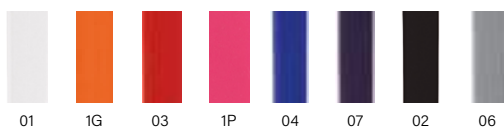

Transparent

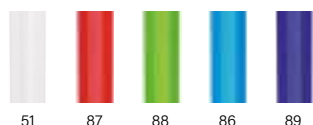

Injection d'une couleur spéciale: ≥ 10.000 unités



*\*En raison du contenu recyclé des matières premières avec lesquelles le produit est fabriqué, nous ne pouvons pas garantir que les couleurs qui apparaissent dans le catalogue, ni les couleurs personnalisées à la carte, aient toujours la même couleur et la même apparence.*

# BIC® SUPER CLIP

1039 / 1E50

## BIC® SUPER CLIP

1039

eColutions® 1E50

A SP: max. 2 coul.

B SP: max. 1 coul.

C DG: Numérique

D BP: Numérique

BP Texture: Numérique

Commande minimale 250 u.

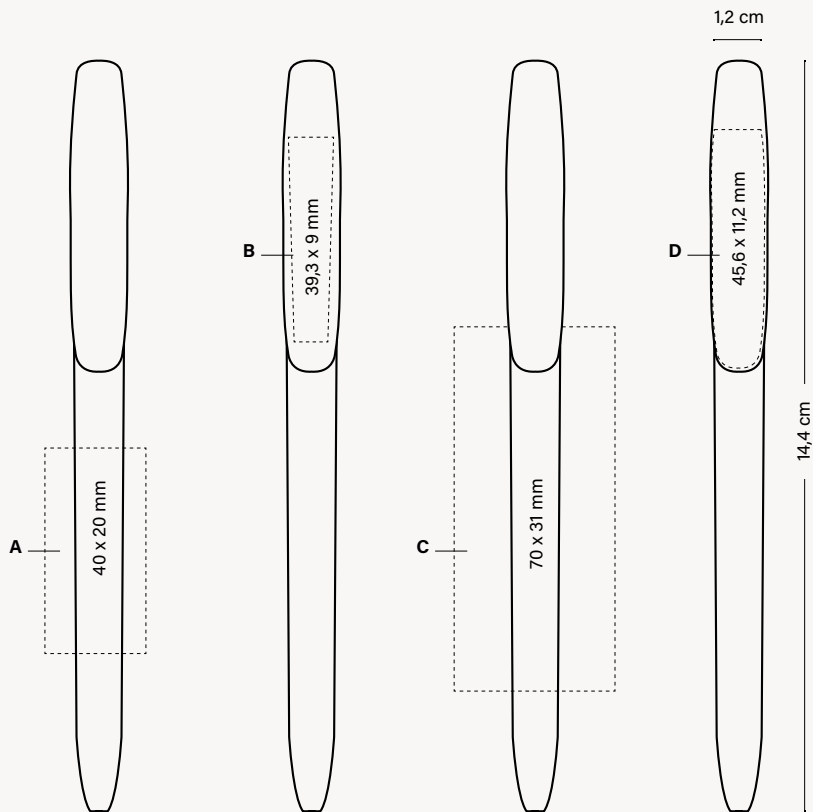

### EMBALLAGE SPÉCIAL EN OPTION



ECO SLEEVE



PLASTIC POUCH



WINDOW BOX



BIC® COLLECTION BOX

+ INFO PAGES 254 À 265

Peut être utilisé comme marque-page

### EMBALLAGE EXTERNE



250 ± 2,6 KG

(1, 2 & 3 unités)

MIX & MATCH



COULEURS PERSONNALISÉES



FABRIQUÉ ET IMPRIMÉ DANS LES USINES BIC



FABRIQUÉ EN ESPAGNE



RESPECTANT LES NORMES



ISO certified

MODES D'ÉCRITURE



BILLE M 0,1 MM

TECHNIQUES D'IMPRESSION



SP SÉRIGRAPHIE



DG DIGITAL



BRIPEPIX™  
BRIPEPIX™ TEXTURE  
BRIPEPIX™ PERSONNALISATION

DURABILITÉ



IMPRIM'VERT®

eColutions®



PIÈCES AUTOMOBILES EN PLASTIQUE



100 % DE L'ÉLECTRICITÉ PROVIENT DE SOURCES RENOUVELABLES

BIC GRAPHIC

INSTRUMENTS D'ÉCRITURE BIC®

AUTRES INSTRUMENTS D'ÉCRITURE

CARNETS

BRIQUETS BIC®/DJEEP® ET ÉTUIS BIC®

EMBALLAGES BIC®

INFORMATIONS GÉNÉRALES

Consultez les pages 272, 276 pour une explication détaillée des icônes.

1073

**BIC® SUPER CLIP ADVANCE**

1073 Opaque

Couleur d'encre





Disponible en corps blanc



MIX & MATCH



COULEURS PERSONNALISÉES



FABRIQUÉ ET IMPRIMÉ DANS LES USINES BIC



FABRIQUÉ EN ESPAGNE



RESPECTANT LES NORMES



MODES D'ÉCRITURE



BILLE M Ø 1 MM

TECHNIQUES D'IMPRESSION



SÉRIGRAPHIE



DIGITAL



BRITEPIX™  
BRITEPIX™ TEXTURE  
BRITEPIX™ PERSONNALISATION

DURABILITÉ



100 % DE L'ÉLECTRICITÉ PROVIENT DE SOURCES RENOUVELABLES

BIC GRAPHIC

INSTRUMENTS D'ÉCRITURE BIC®

AUTRES INSTRUMENTS D'ÉCRITURE

CARNETS

BRIQUETS BIC®/DJEEP® ET ÉTUIS BIC®

EMBALLAGES BIC®

INFORMATIONS GÉNÉRALES

Consultez les pages 272, 276 pour une explication détaillée des icônes.

# BIC® SUPER CLIP ADVANCE

1073

**BIC® SUPER CLIP ADVANCE**  
1073 Opaque

Commande minimale 250 u.  
Combinaison de couleurs standards

**MIX & MATCH** Sans frais supplémentaires

## Clip

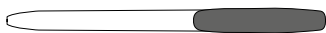

Opaque



## Corps



Opaque

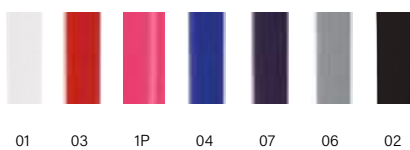

## Section

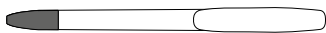

ADVANCE



*Injection d'une couleur spéciale: ≥ 10.000 unités*



# BIC® SUPER CLIP ADVANCE

1073

## BIC® SUPER CLIP ADVANCE

1073

**A SP:** max. 2 coul.

**B SP:** max. 1 coul.

**C DG:** Numérique

**D BP:** Numérique

**BP Texture:** Numérique

Commande minimale 250 u.

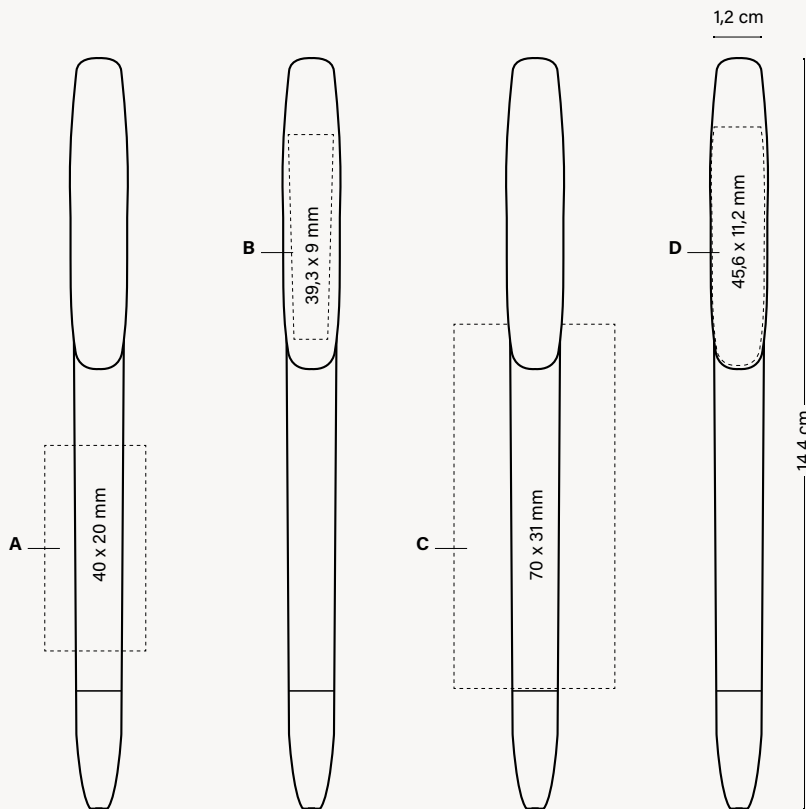

### EMBALLAGE SPÉCIAL EN OPTION



+ INFO PAGES 254 À 265

Peut être utilisé comme marque-page

(1, 2 & 3 unités)

### EMBALLAGE EXTERNE



250 ± 2,6 KG

MIX & MATCH



COULEURS PERSONNALISÉES



FABRIQUÉ ET IMPRIMÉ DANS LES USINES BIC



FABRIQUÉ EN ESPAGNE



RESPECTANT LES NORMES



ISO certified

MODES D'ÉCRITURE



BILLE M Ø 1 MM

TECHNIQUES D'IMPRESSION



SÉRIGRAPHIE



DIGITAL



BRITEPIX™  
BRITEPIX™ TEXTURE  
BRITEPIX™ PERSONNALISATION

DURABILITÉ



100 % DE L'ÉLECTRICITÉ PROVIENT DE SOURCES RENOUVELABLES

BIC GRAPHIC

INSTRUMENTS D'ÉCRITURE BIC®

AUTRES INSTRUMENTS D'ÉCRITURE

CARNETS

BRIQUETS BIC®/DJEEP® ET ÉTUIS BIC®

EMBALLAGES BIC®

INFORMATIONS GÉNÉRALES

Consultez les pages 272-276 pour une explication détaillée des icônes.

BIC® SUPER CLIP GLACÉ

# Découvrez le BIC® Super Clip dans sa version glamour.

1082

**BIC® SUPER CLIP GLACÉ**

1082

Couleur d'encre



47G

76

14G

03G

04G

05G

échelle 1:1

1084

**BIC® SUPER CLIP GLACÉ ADVANCE**

1084

Couleur d'encre



47G/35

05G/35

14G/35

03G/35

04G/35

76/35

échelle 1:1

Service de recharge sur demande

## Section

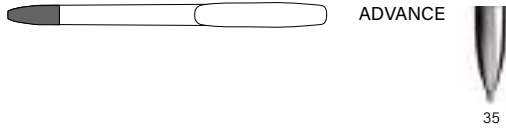

1082 / 1084

**BIC® SUPER CLIP GLACÉ**  
1082

**BIC® SUPER CLIP GLACÉ**  
**ADVANCE**  
1084

**A SP:** max. 1 coul.  
**B SP:** max. 1 coul.

Commande minimale 250 u.  
Combinaison de couleurs standards

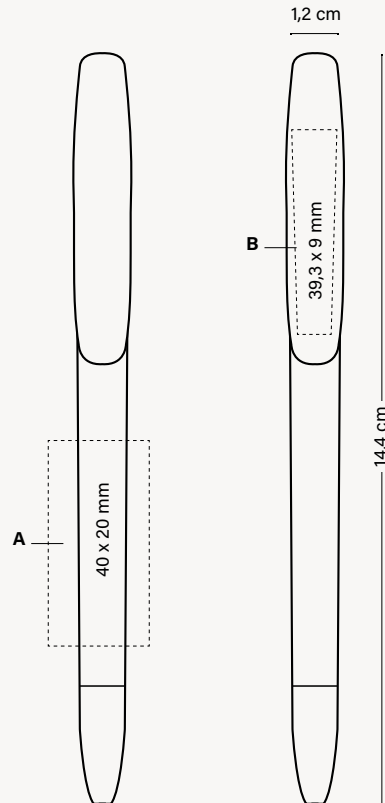

### EMBALLAGE SPÉCIAL EN OPTION



+ INFO PAGES 254 À 265

*Peut être  
utilisé comme  
marque-page*

*(1, 2 & 3 unités)*

### EMBALLAGE EXTERNE



MODES  
D'ÉCRITURE



TECHNIQUES  
D'IMPRESSION



DURABILITÉ



100 % DE L'ÉLECTRICITÉ  
PROVIENT DE SOURCES  
RENOUVELABLES



REGARDEZ LA VIDEO

BIC  
GRAPHIC

INSTRUMENTS  
D'ÉCRITURE BIC®

AUTRES INSTRUMENTS  
D'ÉCRITURE

CARNETS

BRIQUETS BIC®/DJEEP®  
ET ÉTUIS BIC®

EMBALLAGES  
BIC®

INFORMATIONS  
GÉNÉRALES

Consultez les pages 272-276 pour une explication détaillée des icônes.

BIC® SUPER CLIP SOFT & ADVANCE

# Découvrez l'incroyable toucher soyeux de notre BIC® Super Clip.



1083

**BIC® SUPER CLIP SOFT**  
1083

Couleur d'encre



échelle 1:1



02F



03F

07F

1085

**BIC® SUPER CLIP SOFT  
ADVANCE**  
1085

Couleur d'encre



échelle 1:1



02F/35



03F/35

07F/35



Service de  
recharge sur  
demande

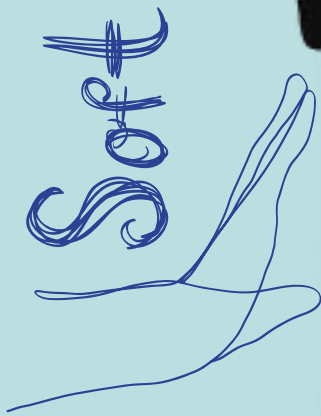

## Section

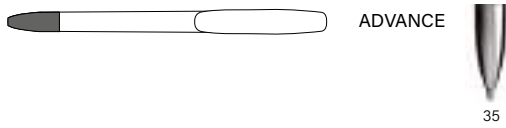

1083 / 1085

**BIC® SUPER CLIP SOFT**  
1083

**BIC® SUPER CLIP SOFT  
ADVANCE**  
1085

A SP: max. 1 coul.

Commande minimale 250 u.  
Combinaison de couleurs standards

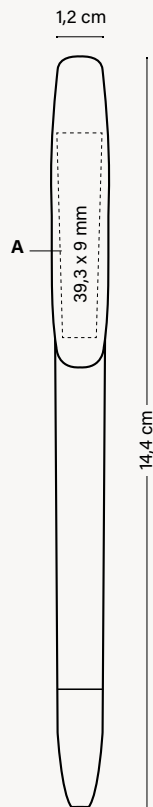

### EMBALLAGE SPÉCIAL EN OPTION



+ INFO PAGES 254 À 265



*Peut être  
utilisé comme  
marque-page*



*(1, 2 & 3 unités)*

### EMBALLAGE EXTERNE



250 ± 2,6 KG



MODES  
D'ÉCRITURE



TECHNIQUES  
D'IMPRESSION



DURABILITÉ



BIC  
GRAPHIC

INSTRUMENTS  
D'ÉCRITURE BIC®

AUTRES INSTRUMENTS  
D'ÉCRITURE

CARNETS

BRIQUETS BIC®/DJEEP®  
ET ÉTUIS BIC®

EMBALLAGES  
BIC®

INFORMATIONS  
GÉNÉRALES

Consultez les pages 272-276 pour une explication détaillée des icônes.

**BIC® SUPER CLIP ORIGIN**

**Le BIC® Super Clip Origin est  
fabriqué à partir d'ingrédients  
naturels\*.**

**ORIGIN  
BIOBASED**

---

Le BIC® Super Clip Origin est fabriqué à partir de matériaux biosourcés composés de polymères naturels, à l'exclusion d'éléments provenant du pétrole et de combustibles fossiles\*.



Fabriqué avec de l'huile de ricin et d'autres ingrédients d'origine végétale.\*



Fabriqué et imprimé dans des usines alimentées avec **100% d'électricité d'énergie renouvelable.**



**\*Corps et clip 100 % biosourcés.**

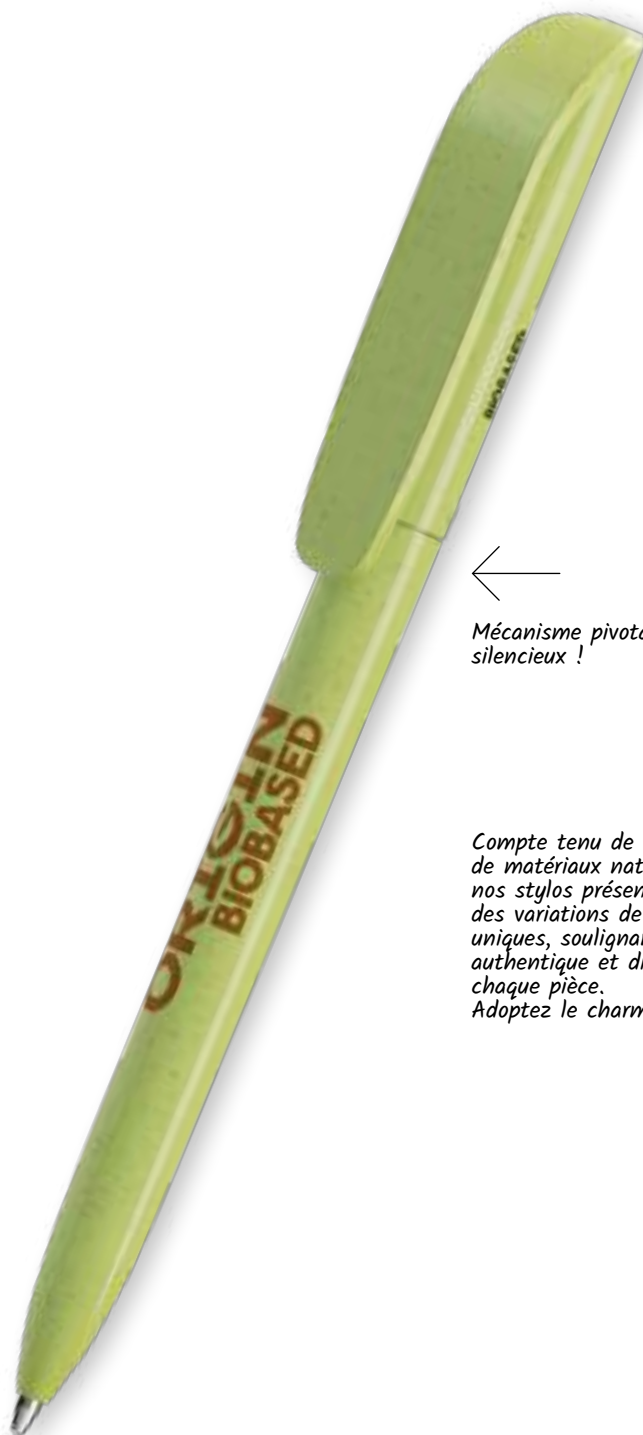

Mécanisme pivotant silencieux !

*Compte tenu de l'utilisation de matériaux naturels, nos stylos présentent des variations de couleur uniques, soulignant la nature authentique et distinctive de chaque pièce. Adoptez le charme naturel !*

6CO

\* Il se réfère au corps et au clip

# ORIGIN BIOBASED

1038

**BIC® SUPER CLIP ORIGIN**

1038 Opaque

Couleur d'encre



**Corps et clip sont fabriqués  
à partir de matériaux 100 %  
biosourcés.**

*\* En raison du contenu recyclé des matières premières avec lesquelles le produit est fabriqué, nous ne pouvons pas garantir que les couleurs qui apparaissent dans le catalogue, ni les couleurs personnalisées à la carte, aient toujours la même couleur et la même apparence. \* Il se réfère au corps et au clip.*

# BIC® SUPER CLIP ORIGIN

1038

## BIC® SUPER CLIP ORIGIN

1038

A SP: max. 1 coul.

Commande minimale 250 u.  
Combinaison de couleurs standards

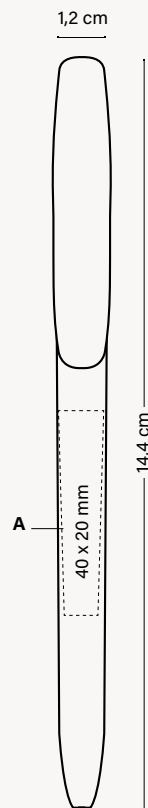

### EMBALLAGE SPÉCIAL EN OPTION



+ INFO PAGES 254 À 265

Peut être  
utilisé comme  
marque-page

(1, 2 & 3 unités)

### EMBALLAGE EXTERNE



250 ± 2,6 KG



FABRIQUÉ ET  
IMPRIMÉ DANS  
LES USINES BIC



FABRIQUÉ EN  
ESPAGNE



RESPECTANT  
LES NORMES



MODS  
D'ÉCRITURE



BILLE M  
Ø 1 MM

TECHNIQUES  
D'IMPRESSIION



SÉRIGRAPHIE

DURABILITÉ



ORIGIN  
BIOBASED



100 % DE L'ÉLECTRICITÉ  
PROVIENT DE SOURCES  
RENOUVELABLES



REGARDEZ LA VIDEO

BIC  
GRAPHIC

INSTRUMENTS  
D'ÉCRITURE BIC®

AUTRES INSTRUMENTS  
D'ÉCRITURE

CARNETS

BRIQUETS BIC®/DJEEP®  
ET ÉTUIS BIC®

EMBALLAGES  
BIC®

INFORMATIONS  
GÉNÉRALES

Consultez les pages 272, 276 pour une explication détaillée des icônes.

BIC® WIDE BODY™

# La taille idéale pour mettre en valeur votre marque !

Corps large et multiples  
possibilités pour optimiser  
votre communication.

Parfait pour vos  
grandes idées

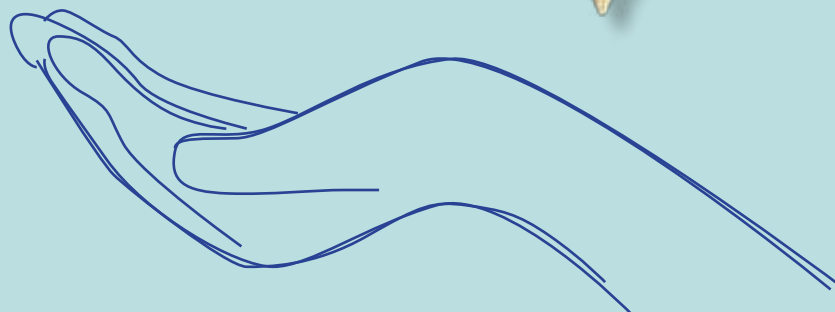

1080

**BIC® WIDE BODY™**  
1080 Opaque

Couleur d'encre  
● ● ● ●

Encre rouge disponible  
sur demande



impression  
360°

échelle 1:1

Disponible en  
corps blanc



l'icône BIC®  
Boy en relief !

1E80

**BIC® WIDE BODY™**  
eColutions® 1E80 Opaque

Couleur d'encre  
● ● ● ●

Encre rouge disponible  
sur demande



impression  
360°

échelle 1:1

Disponible en  
corps blanc



Version ECO.  
Au même prix que la version standard !

**ecolutions®**



FABRIQUÉ À PARTIR DE **98%**  
**DE MATÉRIEL RECYCLÉ\***  
\*Du corps



CAGEOTS DE FRUITS  
ET LÉGUMES

**MIX&  
MATCH**



COULEURS  
PERSONNALISÉES



FABRIQUÉ ET  
IMPRIMÉ DANS  
LES USINES BIC



FABRIQUÉ  
EN ESPAGNE



RESPECTANT  
LES NORMES



MODES  
D'ÉCRITURE



BILLE M  
Ø 1 MM

TECHNIQUES  
D'IMPRESSION



SERIGRAPHIE



DIGITAL

DURABILITÉ



**ecolutions®**



CAGEOTS DE FRUITS  
ET LÉGUMES



100 % DE L'ÉLECTRICITÉ  
PROVIENT DE SOURCES  
RENOUVELABLES

BIC  
GRAPHIC

INSTRUMENTS  
D'ÉCRITURE BIC®

AUTRES INSTRUMENTS  
D'ÉCRITURE

CARNETS

BRIQUETS BIC®/DJEEP®  
ET ÉTUIS BIC®

EMBALLAGES  
BIC®

INFORMATIONS  
GÉNÉRALES

Consultez les pages 272-276 pour une explication détaillée des icônes.

\*Pourcentage calculé sur le poids total du produit cartouche exclue. En raison du contenu recyclé des matières premières avec lesquelles le produit est fabriqué, nous ne pouvons pas garantir que les couleurs qui apparaissent dans le catalogue, ni les couleurs personnalisées à la carte, aient toujours la même couleur et la même apparence.

## 1080

**BIC® WIDE BODY™**  
1080 Givré

Couleur d'encre  
● ● ●



## 1893

**BIC® WIDE BODY™**  
**MINI DIGITAL**  
1893 Opaque

Couleur d'encre  
● ● ●

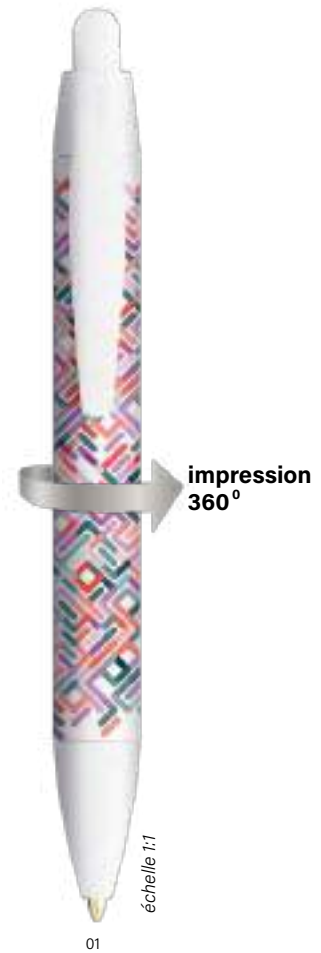

Disponible en  
corps blanc



1080 / 1E80 / 1893

Commande minimale 250 u.  
Combinaison de couleurs standards

**MIX & MATCH** Sans frais supplémentaires

## Bouton

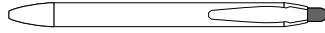

Opaque

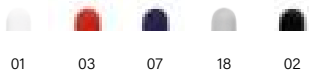

Givré

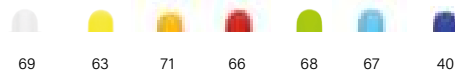

## Clip

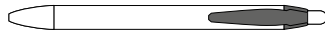

Opaque

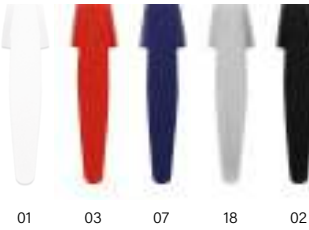

Givré

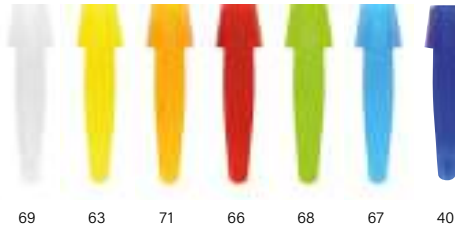

## Corps



Opaque



Givré

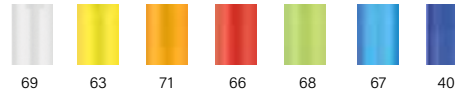

Opaque



**ecolutions®\***



Ajoutez la boucle mobius sur votre BAT sans frais additionnels. Merci de le préciser dans votre bon de commande (en bas à gauche par défaut)

\*Du corps



CAGEOTS DE FRUITS ET LÉGUMES

## Section



Opaque

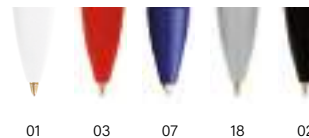

Givré

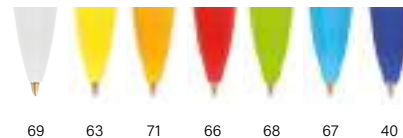

Injection d'une couleur spéciale: ≥ 10.000 unités.



**MIX & MATCH**



COULEURS PERSONNALISÉES



FABRIQUÉ ET IMPRIMÉ DANS LES USINES BIC



FABRIQUÉ EN ESPAGNE



RESPECTANT LES NORMES



MODES D'ÉCRITURE



BILLE M Ø 1 MM

TECHNIQUES D'IMPRESSION



SÉRIGRAPHIE



DIGITAL

DURABILITÉ



ecolutions®



100 % DE L'ÉLECTRICITÉ PROVIENT DE SOURCES RENOUVELABLES



CAGEOTS DE FRUITS ET LÉGUMES

BIC GRAPHIC

INSTRUMENTS D'ÉCRITURE BIC®

AUTRES INSTRUMENTS D'ÉCRITURE

CARNETS

BRIQUETS BIC®/DJEEP® ET ÉTUIS BIC®

EMBALLAGES BIC®

INFORMATIONS GÉNÉRALES

\* En raison du contenu recyclé des matières premières avec lesquelles le produit est fabriqué, nous ne pouvons pas garantir que les couleurs qui apparaissent dans le catalogue, ni les couleurs personnalisées à la carte, aient toujours la même couleur et la même apparence.

1080 / 1E80

**BIC® WIDE BODY™**

1080 Opaque

**eColutions®** 1E80

A/C SP: max. 2 coul.

B/E SP: max. 1 coul.

D DG: Numérique

Commande minimale 250 u. (SP)

Commande minimale 500 u. (DG)

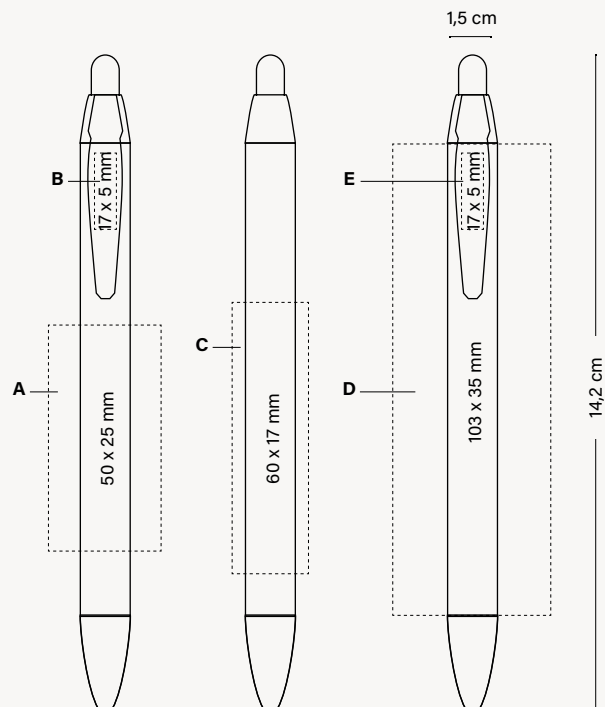

**EMBALLAGE SPÉCIAL EN OPTION**



ECO SLEEVE

+ INFO PAGES 254 À 265



PLASTIC POUCH



WINDOW BOX



BIC® COLLECTION BOX

*Peut être utilisé comme marque-page*

*(1, 2 & 3 unités)*

**EMBALLAGE EXTERNE**



250 ± 2,6KG

1893

**BIC® WIDE BODY™  
MINI DIGITAL**

1893

**A DG:** Numérique

Commande minimale 500 u. (DG)

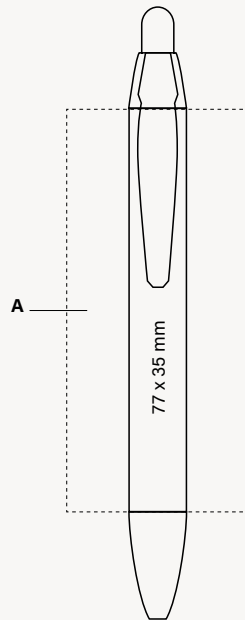

**EMBALLAGE SPÉCIAL EN OPTION**



+ INFO PAGES 254 À 265

*Peut être utilisé comme marque-page*

(1, 2 & 3 unités)

**EMBALLAGE EXTERNE**



**MIX &  
MATCH**



COULEURS PERSONNALISÉES



FABRIQUÉ ET IMPRIMÉ DANS LES USINES BIC



FABRIQUÉ EN ESPAGNE



RESPECTANT LES NORMES



**MODES D'ÉCRITURE**



BILLE M Ø 1 MM

**TECHNIQUES D'IMPRESSION**



SÉRIGRAPHIE



DIGITAL

**DURABILITÉ**



ecolutions®



100 % DE L'ÉLECTRICITÉ PROVIENT DE SOURCES RENOUVELABLES



CAGEOTS DE FRUITS ET LÉGUMES

BIC GRAPHIC

INSTRUMENTS D'ÉCRITURE BIC®

AUTRES INSTRUMENTS D'ÉCRITURE

CARNETS

BRIQUETS BIC®/DJEEP® ET ÉTUIS BIC®

EMBALLAGES BIC®

INFORMATIONS GÉNÉRALES

Consultez les pages 272-276 pour une explication détaillée des icônes.

# BIC® 4 COULEURS®

Le stylo à bille de renommée mondiale le BIC® 4 Couleurs® vous offre la commodité de quatre couleurs d'encre différentes dans un seul stylo à bille.

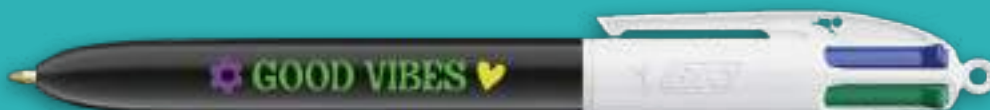

**1101** BIC® 4 Couleurs®  
avec tour de cou

**1100** BIC® 4 Couleurs®

**1100** BIC® 4 Couleurs® Metallic Foil

**1133** BIC® 4 Couleurs® ECO  
**1134** avec tour de cou

**1123** BIC® 4 Couleurs® Rainbow Decor  
**1124** avec tour de cou

**1069** BIC® 4 Couleurs® Bicolor  
**1076** avec tour de cou



**1074** BIC® 4 Couleurs® Gradient  
**1075** avec tour de cou



**1071** BIC® 4 Couleurs® Pastel  
**1072** avec tour de cou



**1102** BIC® 4 Couleurs® Fashion  
**1108** avec tour de cou



**1097** BIC® 4 Couleurs® Sun  
**1098** avec tour de cou



**1109** BIC® 4 Couleurs® Fine  
**1111** avec tour de cou



**1114** BIC® 4 Couleurs® Fluo  
**1116** avec tour de cou



**1057** BIC® 4 Couleurs® Glacé  
**1058** avec tour de cou



**1106** BIC® 4 Couleurs® Shine  
**1107** avec tour de cou



**1060** BIC® 4 Couleurs® Soft  
**1063** avec tour de cou



**1061** BIC® 4 Couleurs® Wood Style  
**1064** avec tour de cou

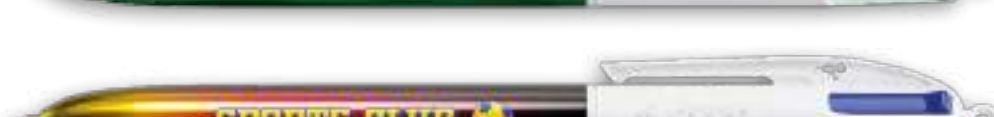

**1067** BIC® 4 Couleurs®  
Flags Collection  
**1068** avec tour de cou



**1099** BIC® 4 Couleurs® 3+1<sup>HB</sup>

BIC  
GRAPHIC

INSTRUMENTS  
D'ÉCRITURE BIC®

AUTRES INSTRUMENTS  
D'ÉCRITURE

CARNETS

BRIQUETS BIC®/DJEEP®  
ET ÉTUIS BIC®

EMBALLAGES  
BIC®

INFORMATIONS  
GÉNÉRALES

# Toujours une icône.

Depuis 1970!



LA SOLUTION POUR UNE COMMUNICATION TOUTE EN COULEURS

1100 / 1101

**BIC® 4 COULEURS®**

1100 Opaque

1101 Avec tour de cou

Couleur d'encre



# BIC® 4 COULEURS®

1100 / 1101

**BIC® 4 COULEURS®**  
1100/1101

- A SP:** max. 4 coul.
- B DG/MF:** Digital print (zone image)
- C BP:** Numérique
- D SP:** 1 coul. (Uniquement disponible pour les parties supérieures blanches)

Commande minimale 250 u. (SP, DG)  
Commande minimale 100 u. (BP)

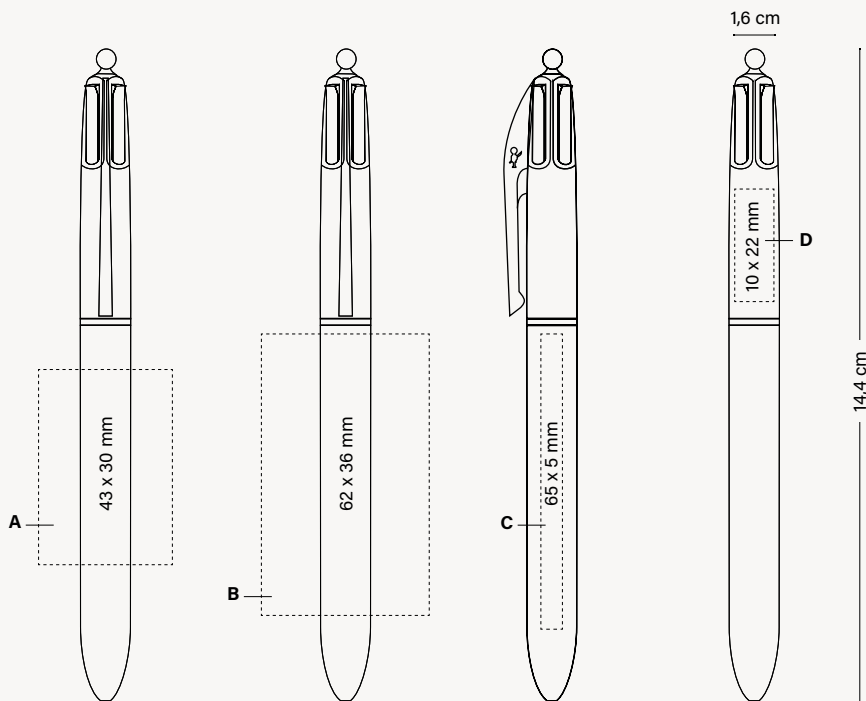

## EMBALLAGE SPÉCIAL EN OPTION



+ INFO PAGES 254 À 265

Peut être utilisé comme marque-page

(1, 2 & 3 unités)

## EMBALLAGE EXTERNE



MODES D'ÉCRITURE



TECHNIQUES D'IMPRESSION



DURABILITÉ



BIC GRAPHIC

INSTRUMENTS D'ÉCRITURE BIC®

AUTRES INSTRUMENTS D'ÉCRITURE

CARNETS

BRIQUETS BIC®/DJEEP® ET ÉTUIS BIC®

EMBALLAGES BIC®

INFORMATIONS GÉNÉRALES

Consultez les pages 272, 276 pour une explication détaillée des icônes.

# Nouveau corps fabriqué à partir de 98 % de plastique recyclé provenant de pièces automobiles\*.

1133 / 1134

**BIC® 4 COULEURS® ECO**

1133 Opaque

1134 Avec tour de cou

Couleur d'encre

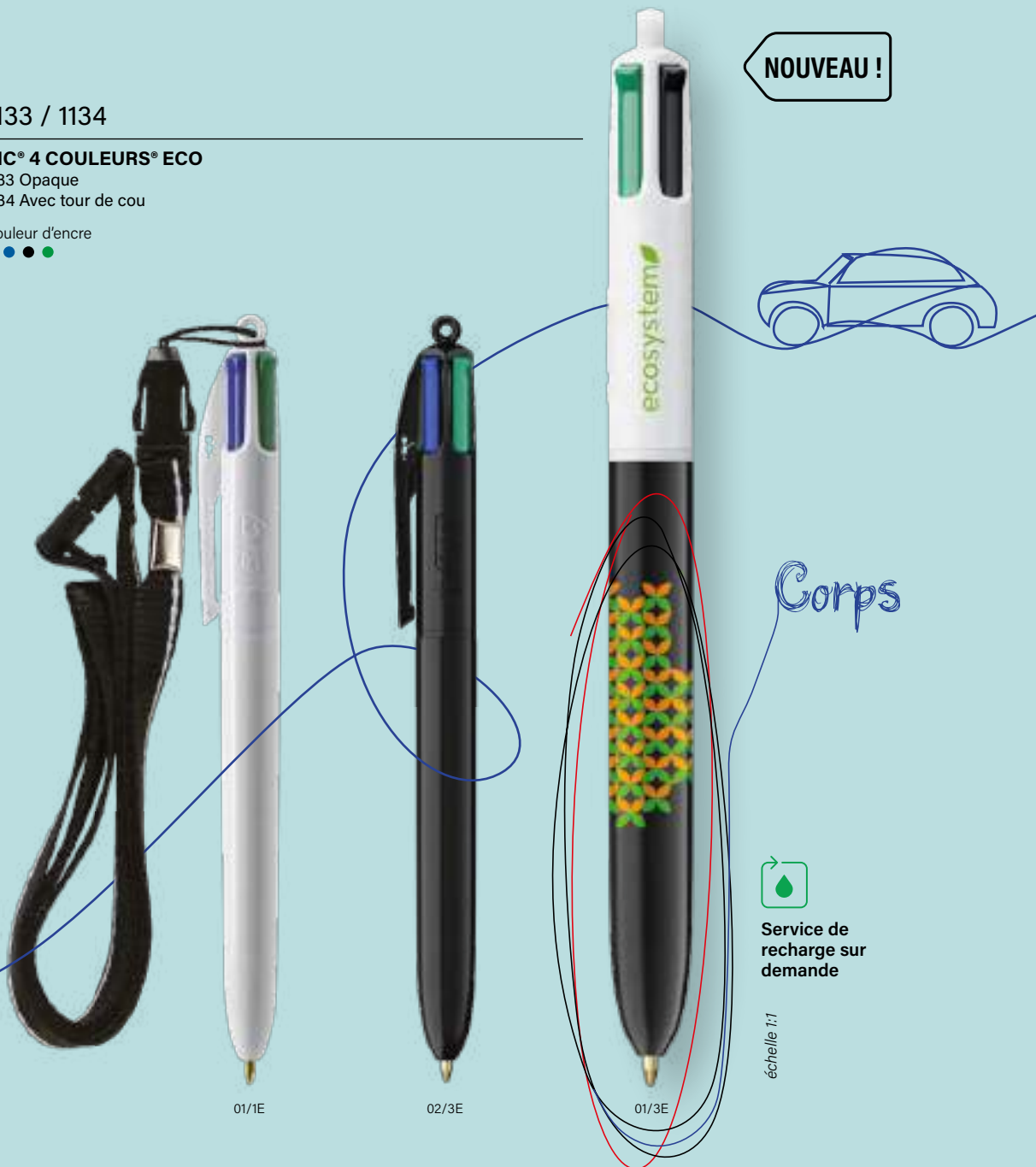

NOUVEAU !

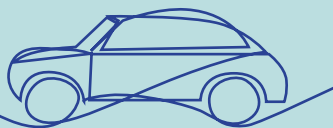

Corps



Service de recharge sur demande

échelle 1:1

01/1E

02/3E

01/3E

# BIC® 4 COULEURS® ECO

1133 / 1134

## BIC® 4 COULEURS® ECO

1133/1134

**A SP:** max. 3 coul.

**B SP:** 1 coul. (Uniquement disponible pour les parties supérieures blanches)

Commande minimale 250 u.

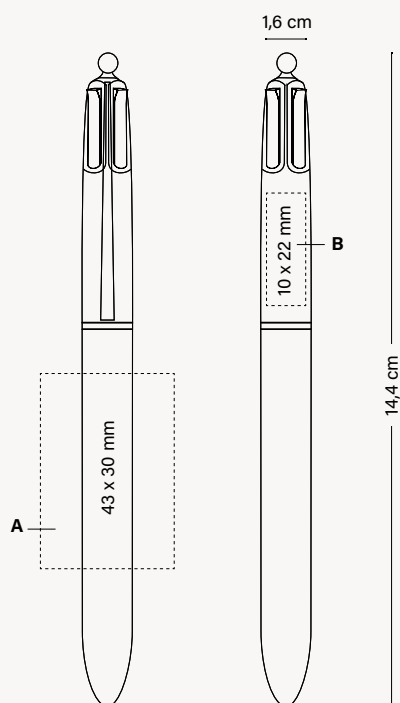

### EMBALLAGE SPÉCIAL EN OPTION



+ INFO PAGES 254 À 265



Peut être utilisé comme marque-page



(1, 2 & 3 unités)

### EMBALLAGE EXTERNE



250 ± 3,2KG



COULEURS PERSONNALISÉES



FABRIQUÉ ET IMPRIMÉ DANS LES USINES BIC



FABRIQUÉ EN FRANCE



RESPECTANT LES NORMES



ISO certified

MODES D'ÉCRITURE



STYLO M Ø 1 MM

TECHNIQUES D'IMPRESSION



SÉRIGRAPHIE

DURABILITÉ



IMPRIM'VERT®



100 % DE L'ÉLECTRICITÉ PROVIENT DE SOURCES RENOUVELABLES

BIC GRAPHIC

INSTRUMENTS D'ÉCRITURE BIC®

AUTRES INSTRUMENTS D'ÉCRITURE

CARNETS

BRIQUETS BIC® / DJEEP® ET ÉTUIS BIC®

EMBALLAGES BIC®

INFORMATIONS GÉNÉRALES

Consultez les pages 272, 276 pour une explication détaillée des icônes.

\* Pourcentage calculé sur la base du poids total du corps. En raison du contenu recyclé des matières premières avec lesquelles le produit est fabriqué, nous ne pouvons pas garantir que les couleurs qui apparaissent dans le catalogue, ni les couleurs personnalisées à la carte, aient toujours la même couleur et la même apparence.

# Colorez votre monde !

Votre vie, votre style.

1123 / 1124

**BIC® 4 COULEURS® RAINBOW DECOR**

1123

1124 Avec tour de cou

Couleur d'encre



Service de recharge sur demande

échelle 1:1

01/9Y

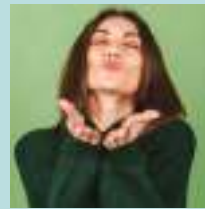

# BIC® 4 COULEURS® RAINBOW DECOR

1123 / 1124

**BIC® 4 COULEURS® RAINBOW DECOR**  
1123/1124

A SP: max. 2 coul.  
B SP: max. 1 coul.

Commande minimale 250 u. (SP)

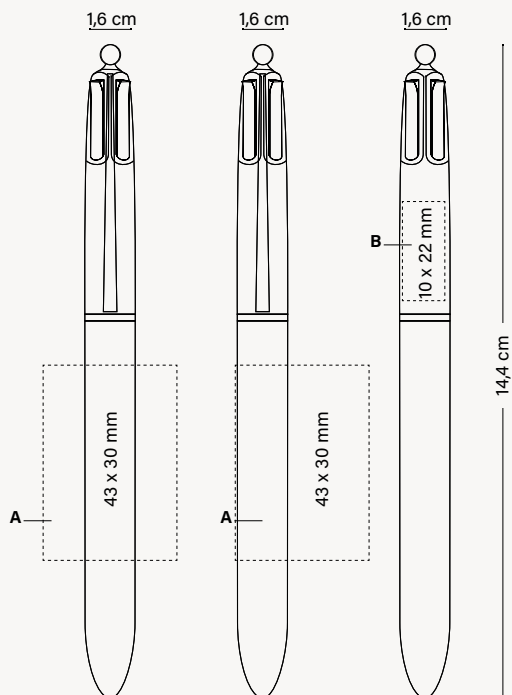

## EMBALLAGE SPÉCIAL EN OPTION



+ INFO PAGES 254 À 265



Peut être  
utilisé comme  
marque-page



(1, 2 & 3 unités)

## EMBALLAGE EXTERNE



250 ± 3,2KG



MODES  
D'ÉCRITURE



TECHNIQUES  
D'IMPRESSION



DURABILITÉ



100 % DE L'ÉLECTRICITÉ  
PROVIENT DE SOURCES  
RENOUVELABLES



REGARDEZ LA VIDEO

BIC  
GRAPHIC

INSTRUMENTS  
D'ÉCRITURE BIC®

AUTRES INSTRUMENTS  
D'ÉCRITURE

CARNETS

BRIQUETS BIC® / DJEEP®  
ET ÉTUIS BIC®

EMBALLAGES  
BIC®

INFORMATIONS  
GÉNÉRALES

Consultez les pages 272-276 pour une explication détaillée des icônes.

# Une esthétique métallique avec une touche artistique.



1069 / 1076

BIC® 4 COULEURS® BICOLOR

1069

1076 Avec tour de cou

Couleur d'encre



01/04G/47



01/05G/47



01/80/47



01/4R/47



Service de recharge sur demande

échelle 1:1

# BIC® 4 COULEURS® BICOLOR

1069 / 1076

**BIC® 4 COULEURS® BICOLOR®**  
1069/1076

A SP: max. 2 coul.  
B SP: max. 1 coul.

Commande minimale 250 u.

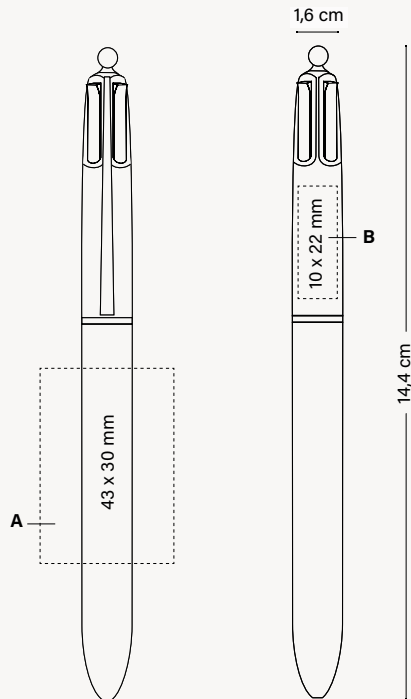

## EMBALLAGE SPÉCIAL EN OPTION



ECO SLEEVE



PLASTIC POUCH



WINDOW BOX



BIC® COLLECTION BOX

+ INFO PAGES 254 À 265

*Peut être utilisé comme marque-page*

*(1, 2 & 3 unités)*

## EMBALLAGE EXTERNE



250 ± 3,2KG



COULEURS PERSONNALISÉES



FABRIQUÉ ET IMPRIMÉ DANS LES USINES BIC



FABRIQUÉ EN FRANCE



RESPECTANT LES NORMES



ISO certified

MODES D'ÉCRITURE



STYLO M Ø 1 MM

TECHNIQUES D'IMPRESSION



SP SÉRIGRAPHIE

DURABILITÉ



IMPRIM'VERT®



100 % DE L'ÉLECTRICITÉ PROVIENT DE SOURCES RENOUVELABLES



REGARDEZ LA VIDEO

BIC GRAPHIC

INSTRUMENTS D'ÉCRITURE BIC®

AUTRES INSTRUMENTS D'ÉCRITURE

CARNETS

BRIQUETS BIC®/DJEEP® ET ÉTUIS BIC®

EMBALLAGES BIC®

INFORMATIONS GÉNÉRALES

Consultez les pages 272-276 pour une explication détaillée des icônes.

# Un look total d'été.

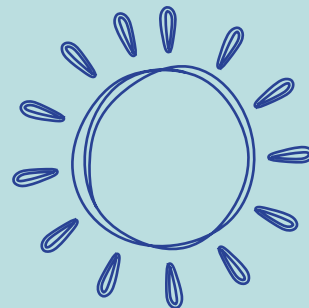

1074 / 1075

**BIC® 4 COULEURS® GRADIENT**

1074

1075 Avec tour de cou

Couleur d'encre



Service de  
recharge sur  
demande

échelle 1:1

01/3G/8D/4R

# BIC® 4 COULEURS® GRADIENT

1074 / 1075

## BIC® 4 COULEURS® GRADIENT

1074/1075

A SP: max. 2 coul.

B SP: max. 1 coul.

Commande minimale 250 u.

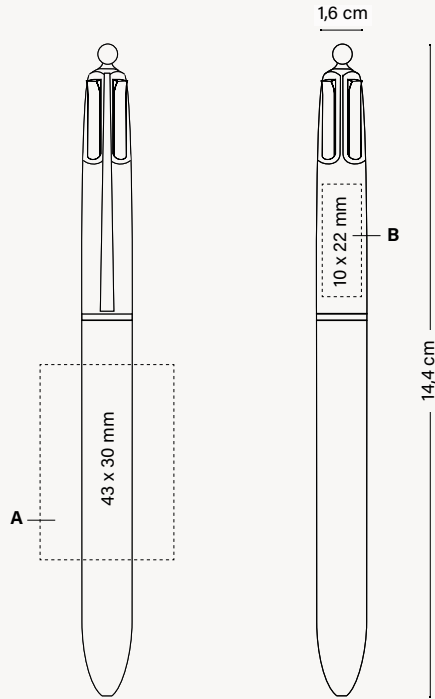

### EMBALLAGE SPÉCIAL EN OPTION



+ INFO PAGES 254 À 265

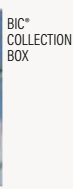
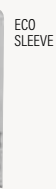

250 ± 3,2KG

Peut être utilisé comme marque-page

(1, 2 & 3 unités)

### EMBALLAGE EXTERNE



COULEURS PERSONNALISÉES



FABRIQUÉ ET IMPRIMÉ DANS LES USINES BIC



FABRIQUÉ EN FRANCE



RESPECTANT LES NORMES



ISO certified

### MODES D'ÉCRITURE



STYLO M Ø 1 MM

### TECHNIQUES D'IMPRESSION



SP SÉRIGRAPHIE

### DURABILITÉ



IMPRIM'VERT®



100 % DE L'ÉLECTRICITÉ PROVIENT DE SOURCES RENOUVELABLES



REGARDEZ LA VIDEO

Consultez les pages 272, 276 pour une explication détaillée des icônes.

BIC GRAPHIC

INSTRUMENTS D'ÉCRITURE BIC®

AUTRES INSTRUMENTS D'ÉCRITURE

CARNETS

BRIQUETS BIC®/DJEEP® ET ÉTUIS BIC®

EMBALLAGES BIC®

INFORMATIONS GÉNÉRALES

# Des couleurs vintages, tout un rêve.

1071 / 1072

**BIC® 4 COULEURS® PASTEL**

1071 Opaque

1072 Avec tour de cou

Couleur d'encre



Service de recharge sur demande

échelle 1:1

# BIC® 4 COULEURS® PASTEL

1071 / 1072

## BIC® 4 COULEURS® PASTEL

1071/1072

A SP: max. 4 coul.

B DG: Digital print

Commande minimale 250 u.

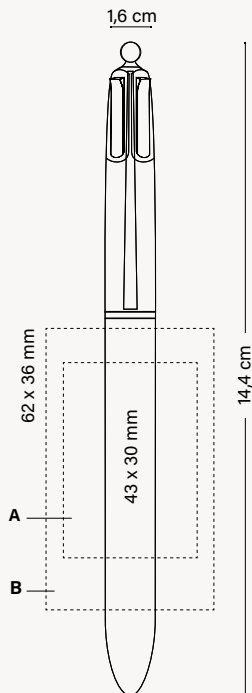

### EMBALLAGE SPÉCIAL EN OPTION



+ INFO PAGES 254 À 265



Peut être utilisé comme marque-page



WINDOW BOX



BIC® COLLECTION BOX

(1, 2 & 3 unités)



250 ± 3,2KG

### EMBALLAGE EXTERNE



COULEURS PERSONNALISÉES



FABRIQUÉ ET IMPRIMÉ DANS LES USINES BIC



FABRIQUÉ EN FRANCE



RESPECTANT LES NORMES



ISO certified

### MODES D'ÉCRITURE



STYLO M Ø 1 MM

### TECHNIQUES D'IMPRESSION



SÉRIGRAPHIE



DIGITAL

### DURABILITÉ



IMPRIM'VERT®



100 % DE L'ÉLECTRICITÉ PROVIENT DE SOURCES RENOUVELABLES



REGARDEZ LA VIDEO

Consultez les pages 272-276 pour une explication détaillée des icônes.

BIC GRAPHIC

INSTRUMENTS D'ÉCRITURE BIC®

AUTRES INSTRUMENTS D'ÉCRITURE

CARNETS

BRIQUETS BIC® / DJEEP® ET ÉTUIS BIC®

EMBALLAGES BIC®

INFORMATIONS GÉNÉRALES

**britePix**  
**DIGITAL** LA SOLUTION POUR  
UNE COMMUNICATION  
TOUTE EN COULEURS

1102 / 1108

**BIC® 4 COULEURS® FASHION**

1102 Opaque

1108 Avec tour de cou

Couleur d'encre



01/01

01/84



Encres Fashion !

impression  
360°



Service de  
recharge sur  
demande

échelle 1:1

01/24

# BIC® 4 COULEURS® FASHION

1102 / 1108

**BIC® 4 COULEURS® FASHION**  
1102/1108

- A SP:** max. 4 coul.
- B DG:** Digital print (zone image)
- C BP:** numérique
- D SP:** max. 1 coul.

Commande minimale 250 u. (SP, DG)  
Commande minimale 100 u. (BP)

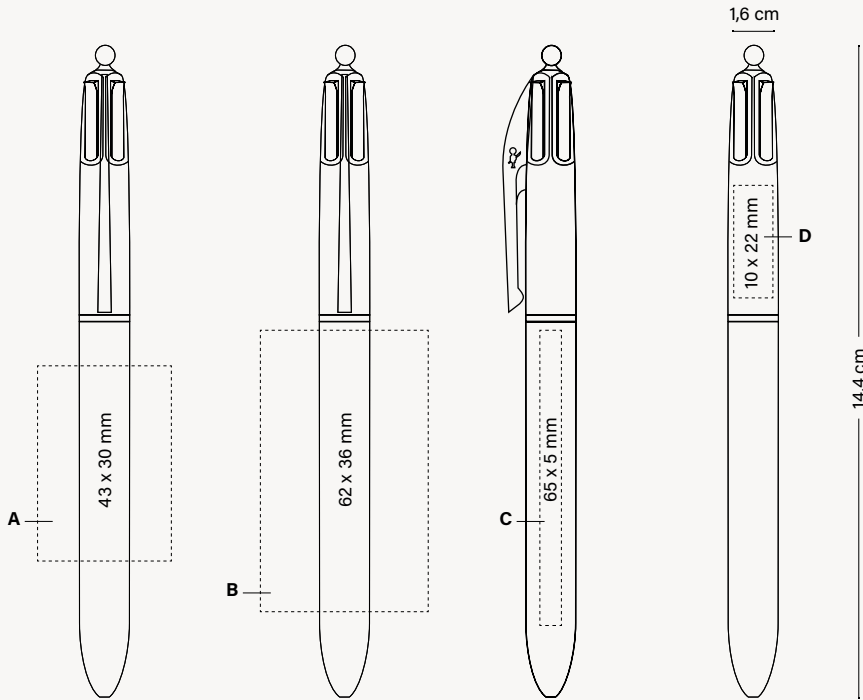

## EMBALLAGE SPÉCIAL EN OPTION



+ INFO PAGES 254 À 265

Peut être utilisé comme marque-page

(1, 2 & 3 unités)

## EMBALLAGE EXTERNE



MODES D'ÉCRITURE



TECHNIQUES D'IMPRESSION



DURABILITÉ



BIC GRAPHIC

INSTRUMENTS D'ÉCRITURE BIC®

AUTRES INSTRUMENTS D'ÉCRITURE

CARNETS

BRIQUETS BIC® / DJEEP® ET ÉTUIS BIC®

EMBALLAGES BIC®

INFORMATIONS GÉNÉRALES

Consultez les pages 272, 276 pour une explication détaillée des icônes.

britePix DIGITAL LA SOLUTION POUR  
UNE COMMUNICATION  
TOUTE EN COULEURS

1097 / 1098

**BIC® 4 COULEURS® SUN**

1097 Opaque  
1098 Avec tour de cou

Couleur d'encre  
● ● ● ●



# BIC® 4 COULEURS® SUN

1097 / 1098

## BIC® 4 COULEURS® SUN

1097/1098

**A SP:** max. 4 coul.

**B DG:** Digital print (zone image)

**C BP:** numérique

**D SP:** max. 1 coul.

Commande minimale 250 u. (SP, DG)

Commande minimale 100 u. (BP)

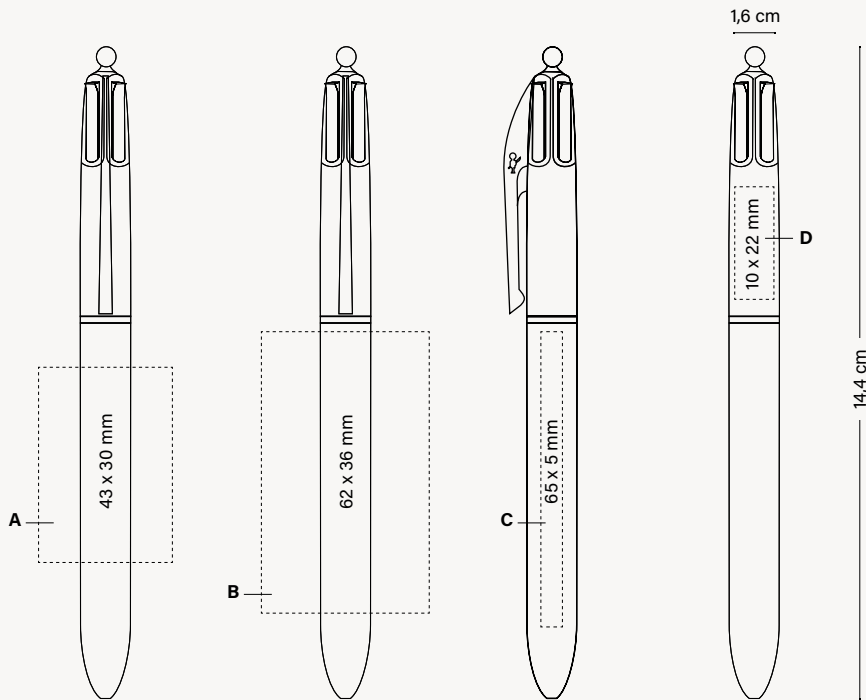

### EMBALLAGE SPÉCIAL EN OPTION



+ INFO PAGES 254 À 265

*Peut être utilisé comme marque-page*

### EMBALLAGE EXTERNE



*(1, 2 & 3 unités)*



COULEURS PERSONNALISÉES



FABRIQUÉ ET IMPRIMÉ DANS LES USINES BIC



FABRIQUÉ EN FRANCE



RESPECTANT LES NORMES



ISO certified

MODES D'ÉCRITURE



STYLO M Ø 1 MM

TECHNIQUES D'IMPRESSION



SP SÉRIGRAPHIE



DG DIGITAL



BP BRITEPIX™  
BRITEPIX™ TEXTURE  
BRITEPIX™ PERSONNALISATION

DURABILITÉ



IMPRIM'VERT®



100 % DE L'ÉLECTRICITÉ PROVIENT DE SOURCES RENOUVELABLES

BIC GRAPHIC

INSTRUMENTS D'ÉCRITURE BIC®

AUTRES INSTRUMENTS D'ÉCRITURE

CARNETS

BRIQUETS BIC® / DJEEP® ET ÉTUIS BIC®

EMBALLAGES BIC®

INFORMATIONS GÉNÉRALES

Consultez les pages 272-276 pour une explication détaillée des icônes.



LA SOLUTION POUR  
UNE COMMUNICATION  
TOUTE EN COULEURS

1109 / 1111

**BIC® 4 COULEURS® FINE**

1109 Opaque  
1111 Avec tour de cou

Couleur d'encre



01/10



impression  
360°



Service de  
recharge sur  
demande

échelle 1:1

01/10

↑  
Pointe de  
0,8 mm !

# BIC® 4 COULEURS® FINE

1109 / 1111

## BIC® 4 COULEURS® FINE

1109/1111

- A SP:** max. 4 coul.
- B DG:** Digital print
- C BP:** numérique
- D SP:** max. 1 coul.

Commande minimale 250 u. (SP, DG)  
Commande minimale 100 u. (BP)

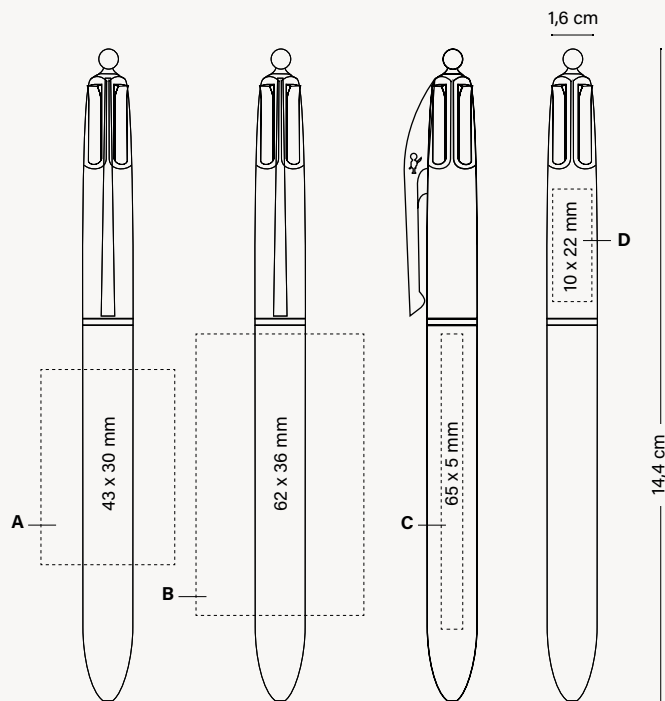

### EMBALLAGE SPÉCIAL EN OPTION



ECO SLEEVE

+ INFO PAGES 254 À 265



PLASTIC POUCH

Peut être utilisé comme marque-page



WINDOW BOX



BIC® COLLECTION BOX

(1, 2 & 3 unités)

### EMBALLAGE EXTERNE



250 ± 3,2KG



COULEURS PERSONNALISÉES



FABRIQUÉ ET IMPRIMÉ DANS LES USINES BIC



FABRIQUÉ EN FRANCE



RESPECTANT LES NORMES



ISO certified

MODES D'ÉCRITURE



STYLO M  
Ø 0,8 MM

TECHNIQUES D'IMPRESSION



SP  
SÉRIGRAPHIE



DG  
DIGITAL



BP  
BRITEPIX™  
BRITEPIX™ TEXTURE  
BRITEPIX™ PERSONNALISATION

DURABILITÉ



IMPRIM'VERT®



100 % DE L'ÉLECTRICITÉ PROVIENT DE SOURCES RENOUVELABLES

BIC GRAPHIC

INSTRUMENTS D'ÉCRITURE BIC®

AUTRES INSTRUMENTS D'ÉCRITURE

CARNETS

BRIQUETS BIC®/DJEEP® ET ÉTUIS BIC®

EMBALLAGES BIC®

INFORMATIONS GÉNÉRALES

Consultez les pages 272, 276 pour une explication détaillée des icônes.

1114 / 1116

**BIC® 4 COULEURS® FLUO**

1114 Opaque  
1116 Avec tour de cou

Couleur d'encre



4 encres  
différentes  
dont 1 fluo !



01/4D



01/4D



Service de  
recharge sur  
demande

échelle 1:1

# BIC® 4 COULEURS® FLUO

1114 / 1116

## BIC® 4 COULEURS® FLUO

1114/1116

**A SP:** max. 4 coul.

**B BP:** numérique

**C SP:** max. 1 coul.

Commande minimale 250 u. (SP)

Commande minimale 100 u. (BP)

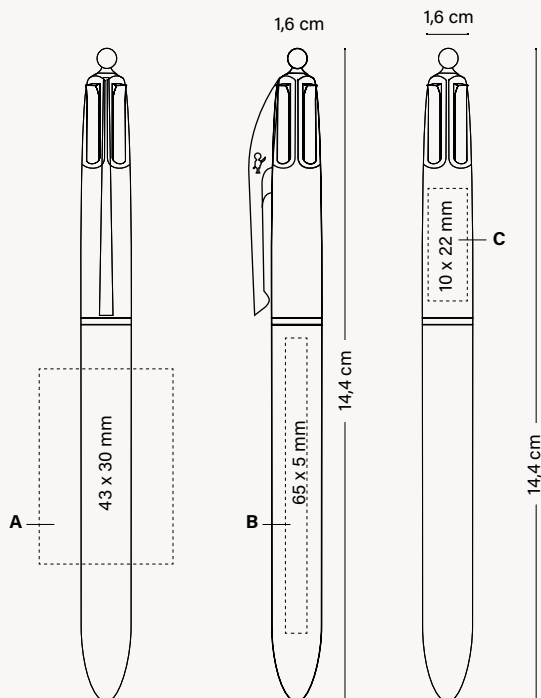

### EMBALLAGE SPÉCIAL EN OPTION



ECO SLEEVE



PLASTIC POUCH



WINDOW BOX



BIC® COLLECTION BOX

+ INFO PAGES 254 À 265

Peut être utilisé comme marque-page

(1, 2 & 3 unités)

### EMBALLAGE EXTERNE



250 ± 3,2KG



COULEURS PERSONNALISÉES



FABRIQUÉ ET IMPRIMÉ DANS LES USINES BIC



FABRIQUÉ EN FRANCE



RESPECTANT LES NORMES



ISO certified

MODES D'ÉCRITURE



STYLO M 0,1 MM

TECHNIQUES D'IMPRESSION



SP SÉRIGRAPHIE



BRITEPIX™  
BRITEPIX™ TEXTURE  
BRITEPIX™ PERSONNALISATION

DURABILITÉ



IMPRIM'VERT®



100 % DE L'ÉLECTRICITÉ PROVIENT DE SOURCES RENOUVELABLES

BIC GRAPHIC

INSTRUMENTS D'ÉCRITURE BIC®

AUTRES INSTRUMENTS D'ÉCRITURE

CARNETS

BRIQUETS BIC® / DJEEP® ET ÉTUIS BIC®

EMBALLAGES BIC®

INFORMATIONS GÉNÉRALES

Consultez les pages 272, 276 pour une explication détaillée des icônes.

# Notre stylo classique dans sa plus belle tenue.

1057 / 1058

**BIC® 4 COULEURS® GLACÉ**

1057

1058 Avec tour de cou

Couleur d'encre

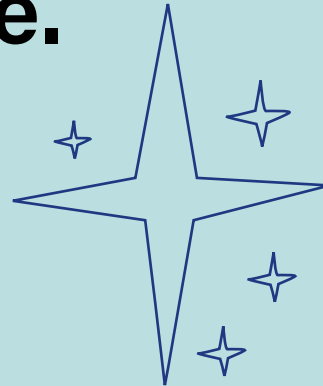

01/76

01/47G

01/03G

01/05G

01/04G

02/47G

02/76

01/14G



Service de recharge sur demande

échelle 1:1

# BIC® 4 COULEURS® GLACÉ

1057 / 1058

**BIC® 4 COULEURS® GLACÉ**  
1057/1058

**A SP:** max. 2 coul.

**B SP:** max. 1 coul. (Uniquement disponible pour les parties supérieures blanches)

Commande minimale 250 u.

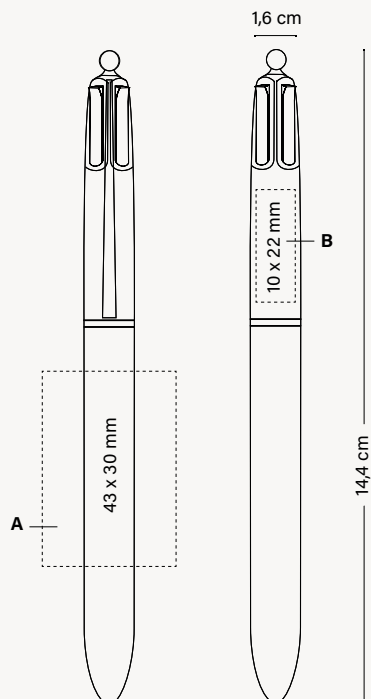

MODES D'ÉCRITURE



TECHNIQUES D'IMPRESSION



DURABILITÉ



## EMBALLAGE SPÉCIAL EN OPTION



+ INFO PAGES 254 À 265



Peut être utilisé comme marque-page



(1, 2 & 3 unités)

## EMBALLAGE EXTERNE



250 ± 3,2KG

BIC GRAPHIC

INSTRUMENTS D'ÉCRITURE BIC®

AUTRES INSTRUMENTS D'ÉCRITURE

CARNETS

BRIQUETS BIC® / DJEEP® ET ÉTUIS BIC®

EMBALLAGES BIC®

INFORMATIONS GÉNÉRALES

Consultez les pages 272-276 pour une explication détaillée des icônes.

1106 / 1107

**BIC® 4 COULEURS® SHINE**

1106

1107 Avec tour de cou

Couleur d'encre



01/75

01/26

01/7G

01/34

01/97

Corps super brillants !



Service de recharge sur demande

échelle 1:1

# BIC® 4 COULEURS® SHINE

1106 / 1107

**BIC® 4 COULEURS® SHINE**  
1106/1107

**A SP:** max. 2 coul.  
**B LE**  
**C LE**  
**D LE:** 360°  
**E SP:** max. 1 coul.

Commande minimale 250 u.

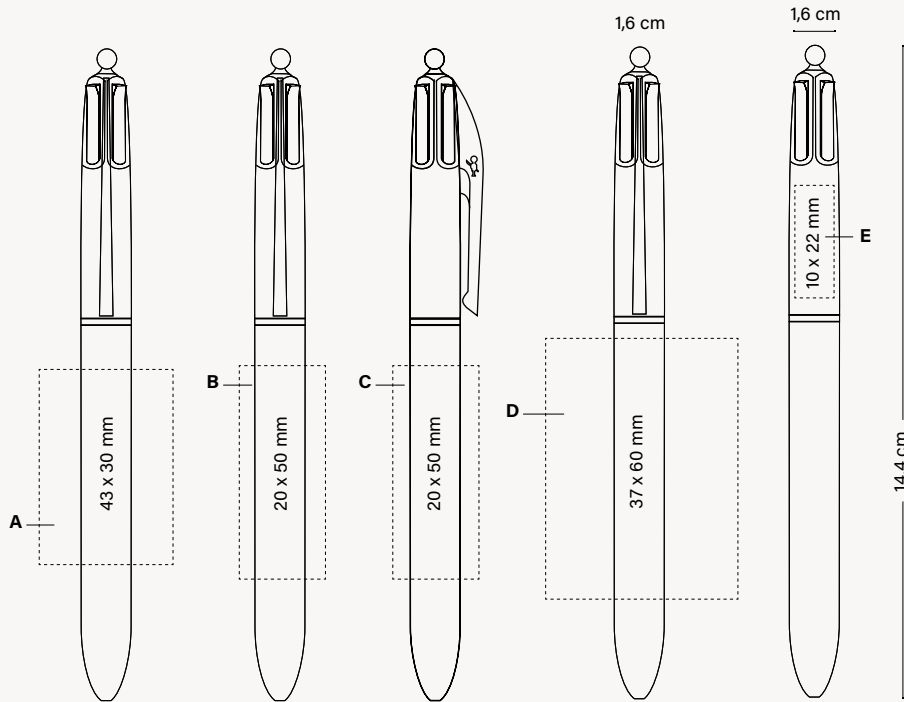

## EMBALLAGE SPÉCIAL EN OPTION



ECO SLEEVE

+ INFO PAGES 254 À 265



PLASTIC POUCH



WINDOW BOX



BIC® COLLECTION BOX

Peut être utilisé comme marque-page

(1, 2 & 3 unités)

## EMBALLAGE EXTERNE



250 ± 3,2KG



COULEURS PERSONNALISÉES



FABRIQUÉ ET IMPRIMÉ DANS LES USINES BIC



FABRIQUÉ EN FRANCE



RESPECTANT LES NORMES



ISO certified

MODES D'ÉCRITURE



STYLO M Ø 1 MM

TECHNIQUES D'IMPRESSION



SP SÉRIGRAPHIE



LE LASER

DURABILITÉ



IMPRIM'VERT\*



100 % DE L'ÉLECTRICITÉ PROVIENT DE SOURCES RENOUVELABLES

BIC GRAPHIC

INSTRUMENTS D'ÉCRITURE BIC®

AUTRES INSTRUMENTS D'ÉCRITURE

CARNETS

BRIQUETS BIC®/DJEEP® ET ÉTUIS BIC®

EMBALLAGES BIC®

INFORMATIONS GÉNÉRALES

Consultez les pages 272, 276 pour une explication détaillée des icônes.



# Un toucher doux que vous ne lâcherez plus !

1060 / 1063

**BIC® 4 COULEURS® SOFT**

1060 Opaque

1063 Avec tour de cou

Couleur d'encre



01/03F



01/02F



02/02F



01/07F



*Un sentiment de douceur entre vos mains*



Service de recharge sur demande

échelle 1:1

Ressentez-le

# BIC® 4 COULEURS® SOFT

1060 / 1063

## BIC® 4 COULEURS® SOFT

1060/1063

A SP: max. 1 coul.

B SP: max. 1 coul. (Uniquement disponible pour les parties supérieures blanches)

Commande minimale 250 u.

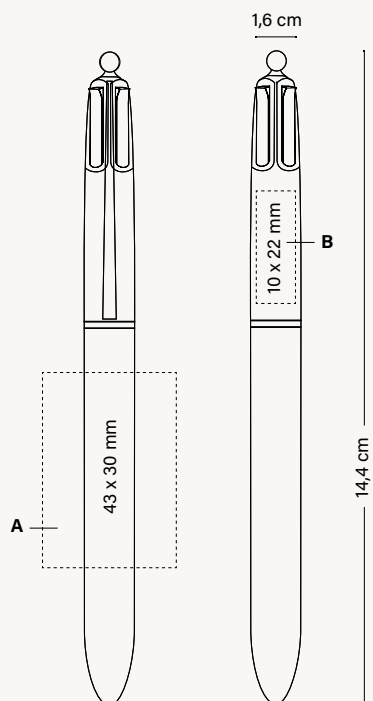

### EMBALLAGE SPÉCIAL EN OPTION



+ INFO PAGES 254 À 265

Peut être utilisé comme marque-page

(1, 2 & 3 unités)

### EMBALLAGE EXTERNE



MODES D'ÉCRITURE



TECHNIQUES D'IMPRESSION



DURABILITÉ



BIC GRAPHIC

INSTRUMENTS D'ÉCRITURE BIC®

AUTRES INSTRUMENTS D'ÉCRITURE

CARNETS

BRIQUETS BIC®/DJEEP® ET ÉTUIS BIC®

EMBALLAGES BIC®

INFORMATIONS GÉNÉRALES

Consultez les pages 272-276 pour une explication détaillée des icônes.



# Laissez-vous impressionner par cette finition spectaculaire !

1061 / 1064

BIC® 4 COULEURS® WOOD STYLE

1061 Opaque

1064 Avec tour de cou

Couleur d'encre



Wood  
Style

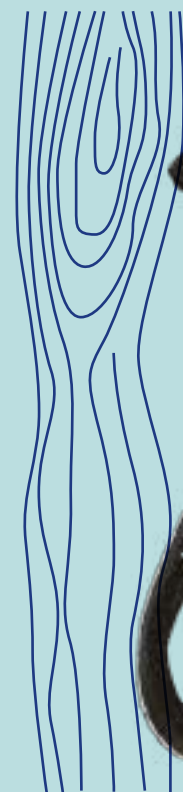

01/6AW



01/05W



02/6AW



01/02W



Ajoutez de la chaleur à votre marque



Service de recharge sur demande

échelle 1:1

# BIC® 4 COULEURS® WOOD STYLE

1061 / 1064

## BIC® 4 COULEURS® WOOD STYLE

1061/1064

**A SP:** max. 2 coul.

**B SP:** max. 1 coul. (Uniquement disponible pour les parties supérieures blanches)

Commande minimale 250 u.

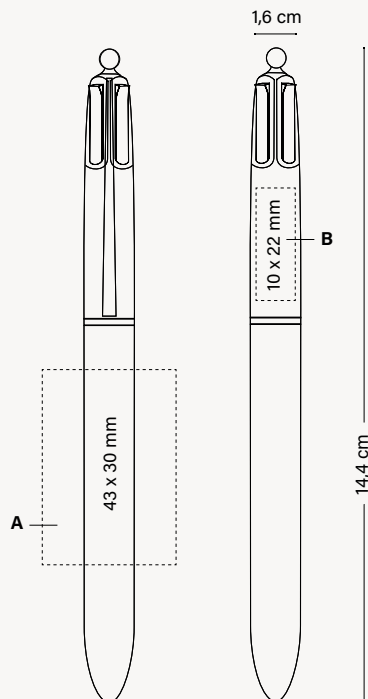

### EMBALLAGE SPÉCIAL EN OPTION



+ INFO PAGES 254 À 265

ECO SLEEVE



Peut être utilisé comme marque-page

PLASTIC POUCH



WINDOW BOX



BIC® COLLECTION BOX

(1, 2 & 3 unités)

### EMBALLAGE EXTERNE



250 ± 3,2KG



COULEURS PERSONNALISÉES



FABRIQUÉ ET IMPRIMÉ DANS LES USINES BIC



FABRIQUÉ EN FRANCE



RESPECTANT LES NORMES



ISO certified

MODS D'ÉCRITURE



STYLO M Ø 1 MM

TECHNIQUES D'IMPRESION



SP SÉRIGRAPHIE

DURABILITÉ



IMPRIM'VERT®



100 % DE L'ÉLECTRICITÉ PROVIENT DE SOURCES RENOUVELABLES

BIC GRAPHIC

INSTRUMENTS D'ÉCRITURE BIC®

AUTRES INSTRUMENTS D'ÉCRITURE

CARNETS

BRIQUETS BIC®/DJEEP® ET ÉTUIS BIC®

EMBALLAGES BIC®

INFORMATIONS GÉNÉRALES

Consultez les pages 272-276 pour une explication détaillée des icônes.

# Célébrer le patrimoine !

1067 / 1068

**BIC® 4 COULEURS® FLAGS COLLECTION**

1067

1068 Avec tour de cou

Couleur d'encre



01/03/47/05

01/02/03/12

02/02/03/12

01/03/47/04

01/03/12/03



Service de recharge sur demande

échelle 1:1

# BIC® 4 COULEURS® FLAGS COLLECTION

1067 / 1068

## BIC® 4 COULEURS® FLAGS COLLECTION

1067/1068

**A SP:** max. 2 coul.

**B SP:** max. 1 coul. (Uniquement disponible pour les parties supérieures blanches)

Commande minimale 250 u.

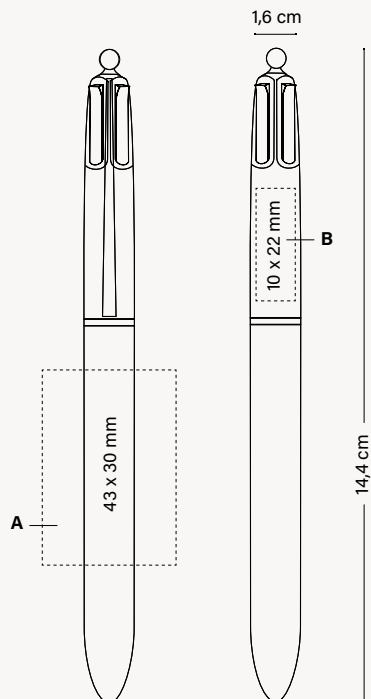

### EMBALLAGE SPÉCIAL EN OPTION



+ INFO PAGES 254 À 265

*Peut être utilisé comme marque-page*

*(1, 2 & 3 unités)*

### EMBALLAGE EXTERNE



MODES D'ÉCRITURE



TECHNIQUES D'IMPRESSION



DURABILITÉ



REGARDEZ LA VIDEO

BIC GRAPHIC

INSTRUMENTS D'ÉCRITURE BIC®

AUTRES INSTRUMENTS D'ÉCRITURE

CARNETS

BRIQUETS BIC®/DJEEP® ET ÉTUIS BIC®

EMBALLAGES BIC®

INFORMATIONS GÉNÉRALES

Consultez les pages 272-276 pour une explication détaillée des icônes.

1099

**BIC® 4 COULEURS® 3+1<sup>HB</sup>**  
1099 Opaque

Couleur d'encre  
● ● ● ●



01/06



01/06

3 stylos +  
1 porte-mines



Service de  
recharge sur  
demande

échelle 1:1



# BIC® 4 COULEURS® 3+1<sup>HB</sup>

1099

**BIC® 4 COULEURS® 3+1<sup>HB</sup>**

1099 Opaque

**A/B LE**

Commande minimale 250 u.

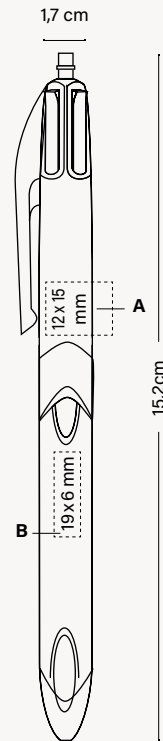

## EMBALLAGE SPÉCIAL EN OPTION



PLASTIC  
POUCH

+ INFO PAGES 254 À 265

*Peut être  
utilisé comme  
marque-page*



BIC®  
COLLECTION  
BOX

(1, 2 & 3 unités)

## EMBALLAGE EXTERNE



250 ± 3,5 KG



COULEURS  
PERSONNALISÉES



FABRIQUÉ ET  
IMPRIMÉ DANS  
LES USINES BIC



RESPECTANT  
LES NORMES



ISO  
certified

## MODES D'ÉCRITURE



STYLO M  
Ø 1 MM



MECHANICAL PENCIL  
MP Ø 0,7MM

## TECHNIQUES D'IMPRESSION



LE  
LASER

## DURABILITÉ



IMPRIM'VERT®



100 % DE L'ÉLECTRICITÉ  
PROVIENT DE SOURCES  
RENOUVELABLES



REGARDEZ LA VIDEO

Consultez les pages 272, 276 pour une explication détaillée des icônes.

BIC  
GRAPHIC

INSTRUMENTS  
D'ÉCRITURE BIC®

AUTRES INSTRUMENTS  
D'ÉCRITURE

CARNETS

BRIQUETS BIC®/DJEEP®  
ET ÉTUIS BIC®

EMBALLAGES  
BIC®

INFORMATIONS  
GÉNÉRALES

# Des accents métalliques et un design moderne, disponible en couleurs classiques et une variété de finitions.

1290

**BIC® METAL PRO**  
1290 Soft

Couleur d'encre



01F



02F



04F



*Confort d'écriture maximal*



*Encre allemande, 8 km d'écriture*

échelle 1:1

# Élegance moderne

1290

**BIC® METAL PRO**  
1290 Brillant

Couleur d'encre



01E



02E



échelle 1:1



MODES D'ÉCRITURE



TECHNIQUES D'IMPRESSION



DURABILITÉ



Consultez les pages 272-276 pour une explication détaillée des icônes.

1290

**BIC® METAL PRO**  
1290 Matte

Couleur d'encre



01D



02D



04D

échelle 17

1290

## BIC® METAL PRO

1290

**A SP:** max. 2 coul.

(Non disponible en finition soft)

**B LE/SP:** max. 1 coul.

**C LE 360°**

Commande minimale 50 u.

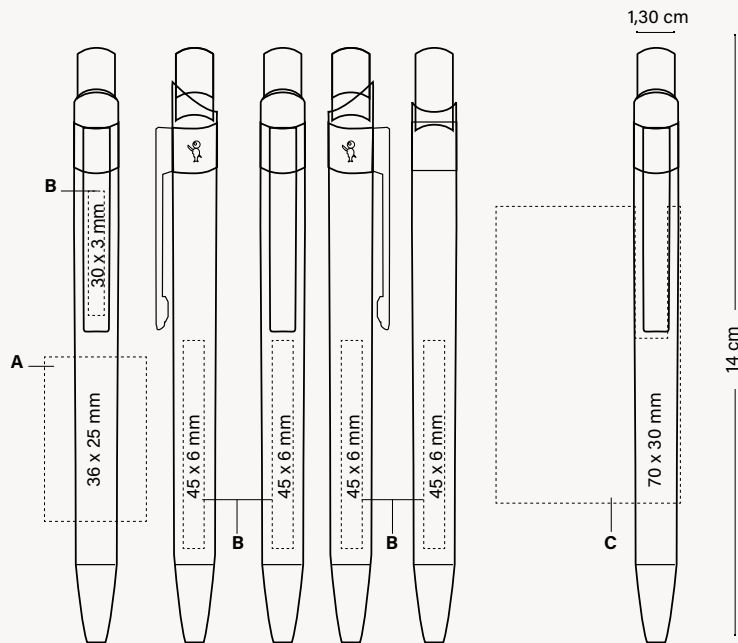

### EMBALLAGE SPÉCIAL EN OPTION



+ INFO PAGES 240 À 245

*Peut être  
utilisé comme  
marque-page*

### EMBALLAGE EXTERNE



### MODES D'ÉCRITURE



### TECHNIQUES D'IMPRESSION



### DURABILITÉ



BIC GRAPHIC

INSTRUMENTS D'ÉCRITURE BIC®

AUTRES INSTRUMENTS D'ÉCRITURE

CARNETS

BRIQUETS BIC®/DJEEP® ET ÉTUIS BIC®

EMBALLAGES BIC®

INFORMATIONS GÉNÉRALES

## BIC® ROLLERS ET GELS

---

Profitez d'une expérience d'écriture douce, fluide et de longue durée.

Parfait pour les droitiers comme pour les gauchers, il glisse facilement sur le papier et ne fait pas de tâches grâce à son encre à séchage rapide.

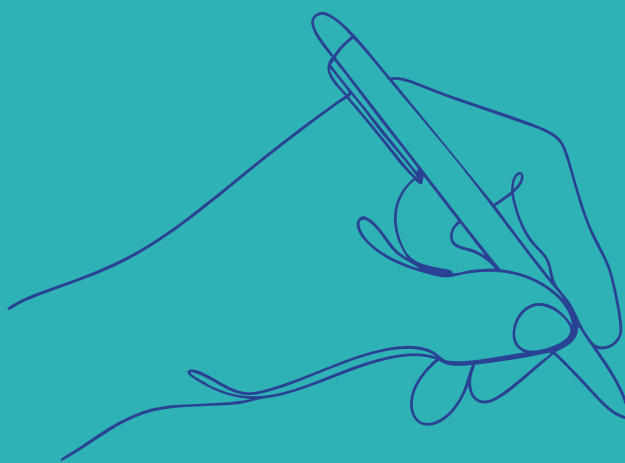



**1187**  
BIC® Grip Roller



**1196**  
BIC® Intensity® Gel Clic  
Opaque



**1196**  
BIC® Intensity® Gel Clic  
Transparent

Performance  
fluide

# BIC® GRIP ROLLER

1187



ÉCRITURE MOYENNE  
Ø 0,7 MM

*Stylo roller à encre liquide, pointe  
moyenne pour une écriture fluide et agréable*

**BIC® GRIP ROLLER**

1187

Couleur d'encre



01/35

●  
Disponible en  
encre bleu



12/35



10/35



59/35



24/35



07/35

●  
Disponible en  
encre bleu



06/35



27/35



02/35

●  
Disponible en  
encre bleu



14/35

échelle 1:1



# BIC® GRIP ROLLER

1187

## BIC® GRIP ROLLER

1187

A/B SP: max. 3 coul.

Commande minimale 250 u.

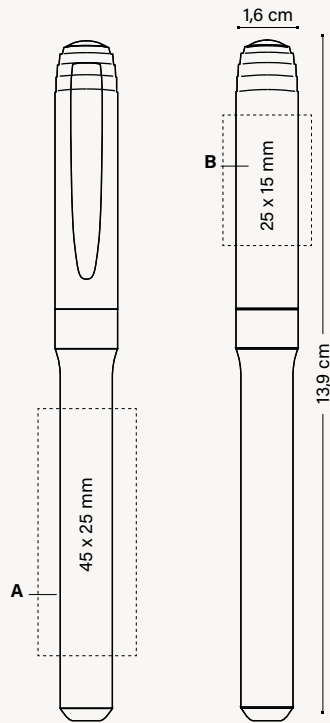

MODES D'ÉCRITURE



TECHNIQUES D'IMPRESSION



DURABILITÉ



### EMBALLAGE SPÉCIAL EN OPTION



ECCO SLEEVE

+ INFO PAGES 240 À 245



PLASTIC POUCH



WINDOW BOX



MARKING SET



BIC® COLLECTION BOX

*Peut être utilisé comme marque-page*

*Peut être utilisé comme marque-page*

(1, 2 & 3 unités)

### EMBALLAGE EXTERNE



250 ± 3 KG

BIC GRAPHIC

INSTRUMENTS D'ÉCRITURE BIC®

AUTRES INSTRUMENTS D'ÉCRITURE

CARNETS

BRIQUETS BIC®/DJEEP® ET ÉTUIS BIC®

EMBALLAGES BIC®

INFORMATIONS GÉNÉRALES

Consultez les pages 272, 276 pour une explication détaillée des icônes.



*l'iconique  
BIC® Boy  
est en relief*

1196

**BIC® INTENSITY®  
GEL CLIC**

1196 Opaque

Couleur d'encre



01



02

échelle 1:1

1196

**BIC® INTENSITY®  
GEL CLIC**

1196 Transparent

Couleur d'encre



92



88



86

échelle 1:1

# BIC® INTENSITY® GEL CLIC

1196

## BIC® INTENSITY® GEL CLIC

1196

**A SP:** max. 2 coul.

**B SP:** max. 4 coul.

Commande minimale 250 u.

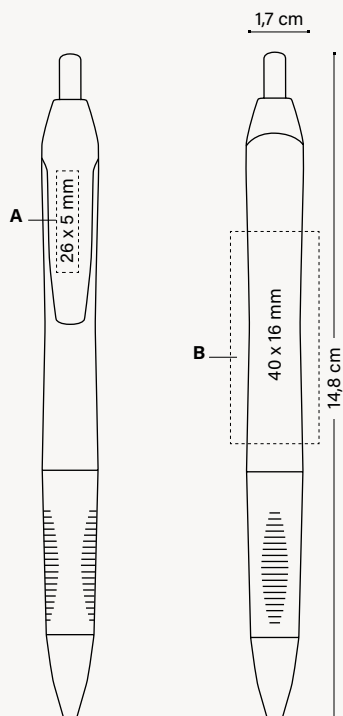

### EMBALLAGE SPÉCIAL EN OPTION



+ INFO PAGES 240 À 245

*Peut être  
utilisé comme  
marque-page*

### EMBALLAGE EXTERNE



MODES  
D'ÉCRITURE



TECHNIQUES  
D'IMPRESSION



DURABILITÉ



BIC  
GRAPHIC

INSTRUMENTS  
D'ÉCRITURE BIC®

AUTRES INSTRUMENTS  
D'ÉCRITURE

CARNETS

BRIQUETS BIC®/DJEEP®  
ET ÉTUIS BIC®

EMBALLAGES  
BIC®

INFORMATIONS  
GÉNÉRALES

Consultez les pages 272-276 pour une explication détaillée des icônes.

## BIC® HIGHLIGHTERS AND MARKERS

---

Les surligneurs et les marqueurs BIC® ont été conçus pour écrire d'une manière visible sur une large gamme de surfaces. Exprimez-vous avec clarté sur n'importe quelle surface. Rendez vos idées visibles et exprimez-vous quelle que soit la surface avec les surligneurs et les marqueurs BIC®.

Marquez - le

Soulignez - le

## FAMILLE BIC® HIGHLIGHTERS AND MARKERS



**1192**  
BIC® Brite Liner® Grip  
Opaque



**1132**  
BIC® Highlighter Flat

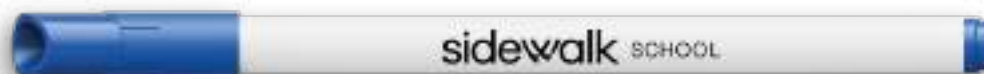

**1651**  
BIC® Velleda® White  
Board Marker Fine



**1213**  
BIC® Velleda® White  
Board Marker Grip



**1214**  
BIC® Mark-it  
Permanent Marker



**1214**  
BIC® Mark-it  
Permanent Marker

BIC  
GRAPHIC

INSTRUMENTS  
D'ÉCRITURE BIC®

AUTRES INSTRUMENTS  
D'ÉCRITURE

CARNETS

BRIQUETS BIC®/DJEEP®  
ET ÉTUIS BIC®

EMBALLAGES  
BIC®

INFORMATIONS  
GÉNÉRALES

1192

BIC® BRITE LINER® GRIP  
1192



*Des couleurs vives pour  
mettre en valeur ou  
souligner vos idées.*

DEUX GROSSEURS :  
**Fin 1,6 mm et  
Épais 3,3 mm.**



*Grip en caoutchouc  
pour plus de précision  
et de contrôle*



*Encre à base  
d'eau.*



12  
●  
Couleur  
d'encre

10  
●  
Couleur  
d'encre

24  
●  
Couleur  
d'encre

59  
●  
Couleur  
d'encre

14  
●  
Couleur  
d'encre

échelle 1:1

# BIC® BRITE LINER® GRIP

1192

## BIC® BRITE LINER® GRIP

1192

A/B SP: max. 3 coul.

Commande minimale 250 u.

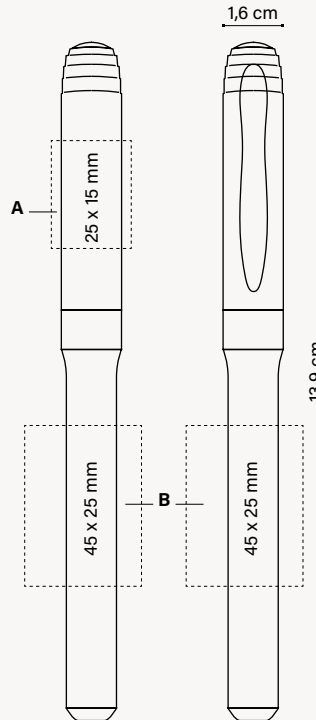

### EMBALLAGE SPÉCIAL EN OPTION



MARKING SET

+ INFO PAGES 262 À 266

Peut être utilisé comme marque-page

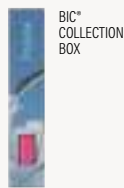

BIC® COLLECTION BOX

(1, 2 & 3 unités)

### EMBALLAGE EXTERNE



250 ± 2,8KG



### MODES D'ÉCRITURE



### TECHNIQUES D'IMPRESSION



### SUITABLE FOR



### DURABILITÉ



BIC GRAPHIC

INSTRUMENTS D'ÉCRITURE BIC®

AUTRES INSTRUMENTS D'ÉCRITURE

CARNETS

BRIQUETS BIC® / DJEEP® ET ÉTUIS BIC®

EMBALLAGES BIC®

INFORMATIONS GÉNÉRALES

Consultez les pages 272, 276 pour une explication détaillée des icônes.

NOUVEAU !

1132

BIC® HIGHLIGHTER FLAT  
1132



12

Couleur  
d'encre



10

Couleur  
d'encre



59

Couleur  
d'encre



14

Couleur  
d'encre

échelle 1:1

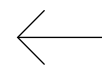

SOULIGNE EN DEUX  
GROSSEURS :  
**Fin 1,2 mm et  
Épais 4,6 mm.**

Encre à base d'eau.  
Encre ultra fluorescente contenant jusqu'à  
95 % d'ingrédients d'origine naturelle.

# BIC® HIGHLIGHTER FLAT

1132

## BIC® HIGHLIGHTER FLAT

1132

A BP : Numérique

Commande minimale 250 u.

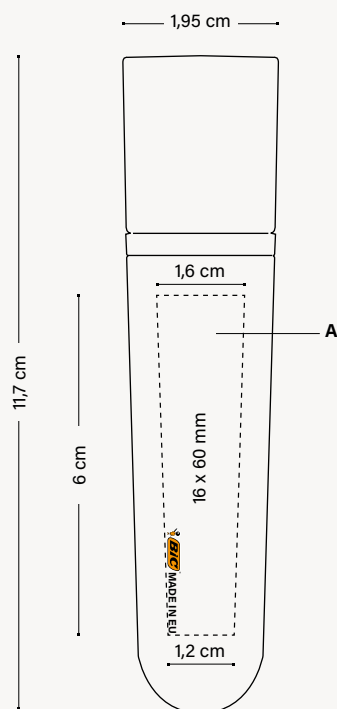

### EMBALLAGE EXTERNE



MODES D'ÉCRITURE



TECHNIQUES D'IMPRESSION



DURABILITÉ



BIC GRAPHIC

INSTRUMENTS D'ÉCRITURE BIC®

AUTRES INSTRUMENTS D'ÉCRITURE

CARNETS

BRIQUETS BIC®/DJEEP® ET ÉTUIS BIC®

EMBALLAGES BIC®

INFORMATIONS GÉNÉRALES

Consultez les pages 272-276 pour une explication détaillée des icônes.

# BIC® VELLEDA® WHITE BOARD MARKER FINE

Velleda®

1651

**BIC® VELLEDA® WHITE BOARD MARKER FINE**  
1651



01/04

●  
Couleur d'encre



01/02

●  
Couleur d'encre

échelle 1:1

1651

**BIC® VELLEDA® WHITE BOARD MARKER FINE**  
1651

A SP: max. 1 coul.

Commande minimale 500 u.

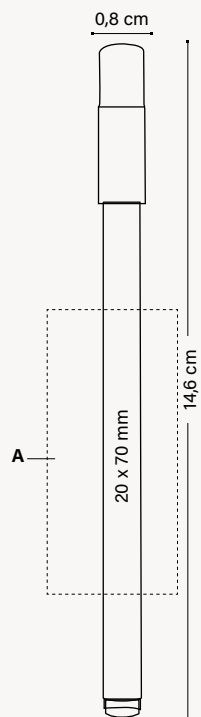

## EMBALLAGE SPÉCIAL EN OPTION



MARKING SET

Disponible en set !

+ INFO PAGES 262 À 266

Peut être utilisé comme marque-page

## EMBALLAGE EXTERNE



500 ± 3,2KG



FABRIQUÉ ET IMPRIMÉ DANS LES USINES BIC



FABRIQUÉ EN FRANCE



RESPECTANT LES NORMES



MINE RÉSISTANTE



## MODES D'ÉCRITURE



MARQUEUR POINTE OGIVE MK

## TECHNIQUES D'IMPRESSION



SÉRIGRAPHIE

## DURABILITÉ





1213

**BIC® VELLEDA® WHITE BOARD MARKER GRIP**  
1213



Grip en caoutchouc pour plus de précision et de contrôle

échelle 1:1

01/02  
●  
Couleur d'encre

1213

**BIC® VELLEDA® WHITE BOARD MARKER GRIP**  
1213

A/B SP: max. 3 coul.

Commande minimale 250 u.

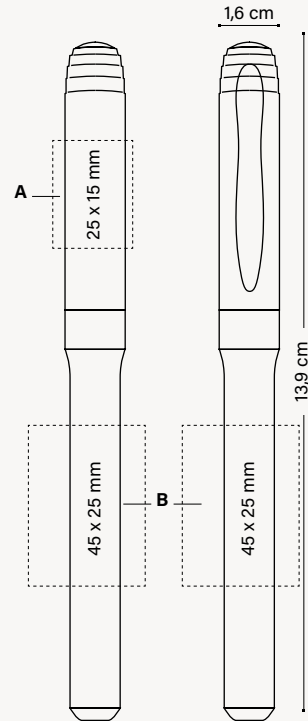

**EMBALLAGE SPÉCIAL EN OPTION**



MARKING SET

Disponible en set !

+ INFO PAGES 262 À 266

Peut être utilisé comme marque-page

**EMBALLAGE EXTERNE**



250 ± 2,7KG



FABRIQUÉ ET IMPRIMÉ DANS LES USINES BIC



RESPECTANT LES NORMES



MINE RÉSISTANTE

**MODES D'ÉCRITURE**



MARQUEUR POINTE OGIVE MK

**TECHNIQUES D'IMPRESSION**



SÉRIGRAPHIE

**DURABILITÉ**



# BIC® MARK-IT PERMANENT MARKER

1214

**BIC® MARK-IT PERMANENT MARKER**

1214



01/02  
●  
Couleur d'encre

01/04  
●  
Couleur d'encre

←  
*Grip en caoutchouc pour plus de précision et de contrôle*

1214

**BIC® MARK-IT PERMANENT MARKER**  
1214

A/B SP: max. 3 coul.

Commande minimale 250 u.

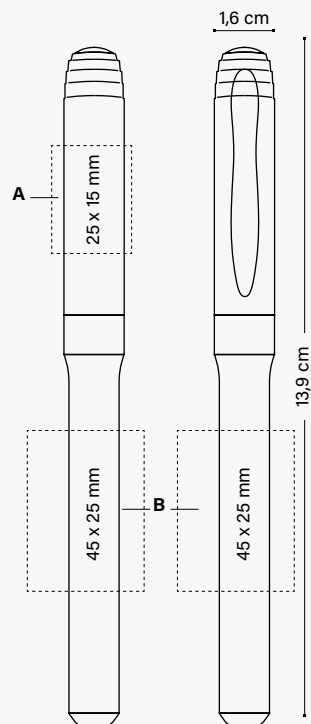

**EMBALLAGE SPÉCIAL EN OPTION**



MARKING SET

*Maintenant disponible en set !*

+ INFO PAGES 262 À 266

*Peut être utilisé comme marque-page*

**EMBALLAGE EXTERNE**



250 ± 2,8KG



FABRIQUÉ ET IMPRIMÉ DANS LES USINES BIC



RESPECTANT LES NORMES



MINE RÉSISTANTE

**MODES D'ÉCRITURE**



MARQUEUR POINTE OGIVE MK

**TECHNIQUES D'IMPRESSIION**



SÉRIGRAPHIE

**DURABILITÉ**



# BIC® PERMANENT MARKER ECOLUTIONS®

ecolutions



FABRIQUÉ À PARTIR DE  
**52% DE MATÉRIEL RECYCLÉ\***

Ajoutez la boucle mobius sur votre BAT sans frais additionnels. Merci de le préciser dans votre bon de commande (en bas à gauche par défaut)

\*Hors système d'encre



EMBALLAGES  
PHARMACEUTIQUES

1210

**BIC® PERMANENT  
MARKER**  
ecolutions® 1210

A SP: max. 1 coul.

Commande minimale 250 u.

1210

**BIC® PERMANENT  
MARKER**  
ecolutions® 1210



échelle 1:1

02

●  
Couleur  
d'encre

02

●  
Couleur  
d'encre

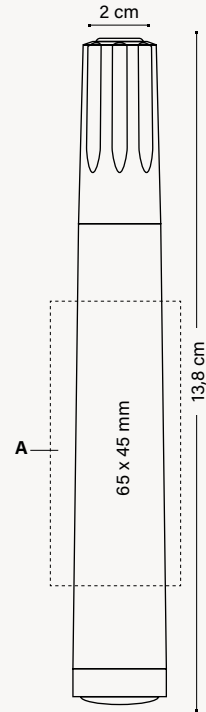

EMBALLAGE EXTERNE



250 ± 2,6KG



FABRIQUÉ ET  
IMPRIMÉ DANS  
LES USINES BIC

RESPECTANT  
LES NORMES



MINE  
RÉSISTANTE

ISO  
certified

MODES D'ÉCRITURE



MARQUEUR POINTE  
OGIVE MK

TECHNIQUES D'IMPRESSION



SP SÉRIGRAPHIE

DURABILITÉ



PHARMACEUTICAL  
WASTE



\*Pourcentage calculé sur le poids total du produit cartouche exclue. En raison du contenu recyclé des matières premières avec lesquelles le produit est fabriqué, nous ne pouvons pas garantir que les couleurs qui apparaissent dans le catalogue, ni les couleurs personnalisées à la carte, aient toujours la même couleur et la même apparence.

Toujours prêts avec ces  
porte-mines de grande  
qualité.

Ils sont solides et leurs  
mines sont résistantes.

Toujours précis

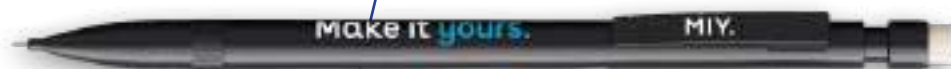

**1120**  
BIC® Matic®  
Opaque



**1028**  
BIC® Media Clic  
Porte-Mines Opaque

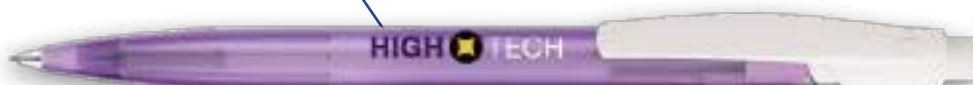

**1028**  
BIC® Media Clic  
Porte-Mines Givré



**1021**  
BIC® Media Clic Grip  
Porte-Mines Givré



**1E21**  
BIC® Media Clic Grip Evolutions®  
Porte-Mines Opaque

1120

BIC® MATIC®  
1120 Opaque



02/02



12/12



03/03



07/07



01/01

échelle 1:1

1120

**BIC® MATIC®**  
1120

A SP: max. 1 coul.  
B/C: max. 2 coul.

Commande minimale 500 u.

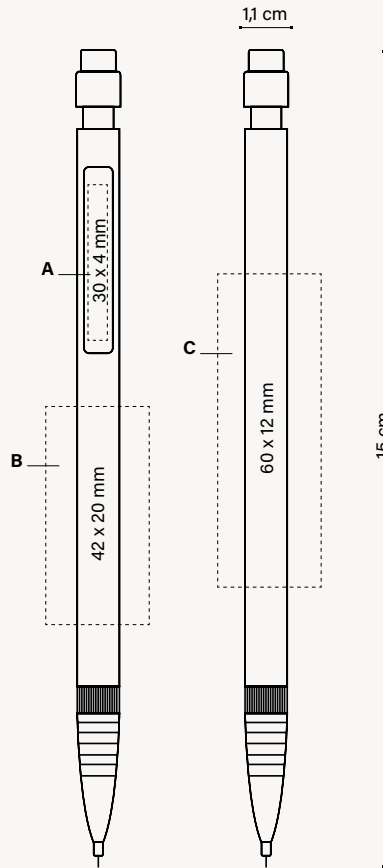

**EMBALLAGE SPÉCIAL EN OPTION**



PLASTIC  
POUCH

+ INFO PAGES 240 À 245

*Peut être  
utilisé comme  
marque-page*

**EXTERNAL PACKAGING**



500 ± 3,1 KG



FABRIQUÉ ET  
IMPRIMÉ DANS  
LES USINES BIC



FABRIQUÉ  
EN FRANCE



RESPECTANT  
LES NORMES



ISO  
certified



ÉCRITURE PLUS  
DOUCE ET FONCÉE



FACILE À UTILISER  
ET À EFFACER



2 MINES  
DE 9 CM

**MODES  
D'ÉCRITURE**



PORTE-MINES MP  
Ø 0,7 MM

**TECHNIQUES  
D'IMPRESSION**



SP  
SÉRIGRAPHIE

**DURABILITÉ**



IMPRIM'VERT®

1028  *L'icône BIC® Boy est en relief*

**BIC® MEDIA CLIC**  
1028 Porte-mines  
Opaque



échelle 1:1

5C

1028

**BIC® MEDIA CLIC**  
1028 Porte-mines  
Givré



échelle 1:1

39

# BIC® MEDIA CLIC GRIP PORTE-MINES

Version ECO.  
Au même prix que la version standard !

**ecolutions®**



FABRIQUÉ À PARTIR DE **98%**  
**DE MATÉRIEL RECYCLÉ\***  
\*Du corps



PIÈCES AUTOMOBILES  
EN PLASTIQUE

1021

**BIC® MEDIA CLIC GRIP**

1021 Porte-mines  
Givré



71/69



82/69



40/69

échelle 1:1

1E21

**BIC® MEDIA CLIC GRIP**

**ecolutions®** 1E21 Porte-mines  
Opaque



01/03



01/05



01/02



01/07

échelle 1:1

\* Pourcentage calculé sur le poids total du produit. En raison du contenu recyclé des matières premières avec lesquelles le produit est fabriqué, nous ne pouvons pas garantir que les couleurs qui apparaissent dans le catalogue, ni les couleurs personnalisées à la carte, aient toujours la même couleur et la même apparence.

# BIC® MEDIA CLIC PORTE-MINES

1028

**BIC® MEDIA CLIC**  
1028 Porte-mines

1021 / 1E21

**BIC® MEDIA CLIC GRIP**  
1021 Porte-mines  
eColutions® 1E21 Porte-mines

**MIX & MATCH** Sans frais supplémentaires

Commande minimale 500 u.  
Combinaison de couleurs standards

## Clip



Opaque

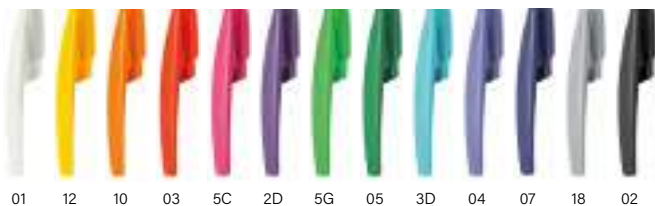

Givré



## Corps



Opaque



5C

Givré



39

## Corps et Grip

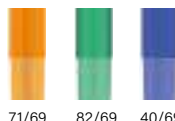

71/69 82/69 40/69



LA SOLUTION POUR UNE  
COMMUNICATION TOUT  
EN COULEURS

**ecolutions®**



PIÈCES AUTOMOBILES  
EN PLASTIQUE

Combinaison de  
couleurs standards\*

**Corps et Grip**

Opaque



01/03 01/05 01/07 01/02



Ajoutez la boucle mobius  
sur votre BAT sans frais  
additionnels. Merci  
de le préciser dans  
votre bon de commande  
(en bas à gauche  
par défaut)

Toute la gamme de couleurs est disponible en Digital BritePix™

Injection d'une couleur spéciale: ≥ 10.000 unités 1028  
Injection d'une couleur spéciale: ≥ 20.000 unités 1021 / 1E21



**MIX & MATCH**



FABRIQUÉ ET  
IMPRIMÉ DANS  
LES USINES BIC



COULEURS  
PERSONNALISÉES



MODES D'ÉCRITURE



PORTE-MINE MP

TECHNIQUES D'IMPRESSION



SÉRIGRAPHIE



DIGITAL

DURABILITÉ



PIÈCES  
AUTOMOBILES  
EN PLASTIQUE

\*En raison du contenu recyclé des matières premières avec lesquelles le produit est fabriqué, nous ne pouvons pas garantir que les couleurs qui apparaissent dans le catalogue, ni les couleurs personnalisées à la carte, aient toujours la même couleur et la même apparence.

# BIC® MEDIA CLIC PORTE-MINES

1028

## BIC® MEDIA CLIC

1028 Porte-mines

A SP: max. 4 coul.

B SP: max. 2 coul.

C DG: Numérique

Commande minimale 500 u.

1021 / 1E21

## BIC® MEDIA CLIC GRIP

1021 Porte-mines

ECOolutions® 1E21 Porte-mines

D SP: max. 4 coul.

E SP: max. 2 coul.

F DG: Numérique

Commande minimale 500 u.

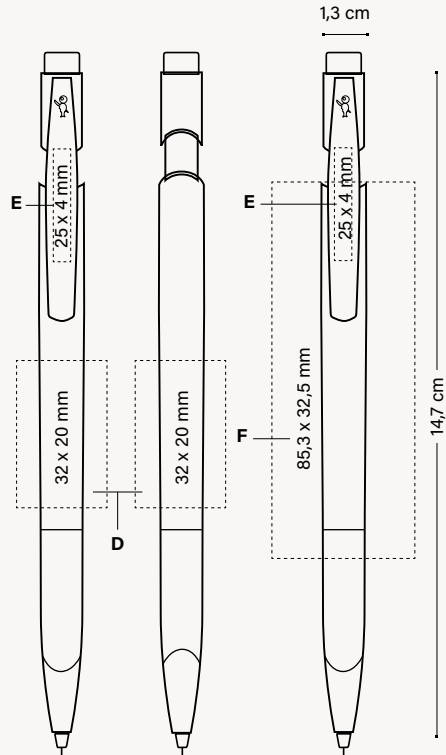
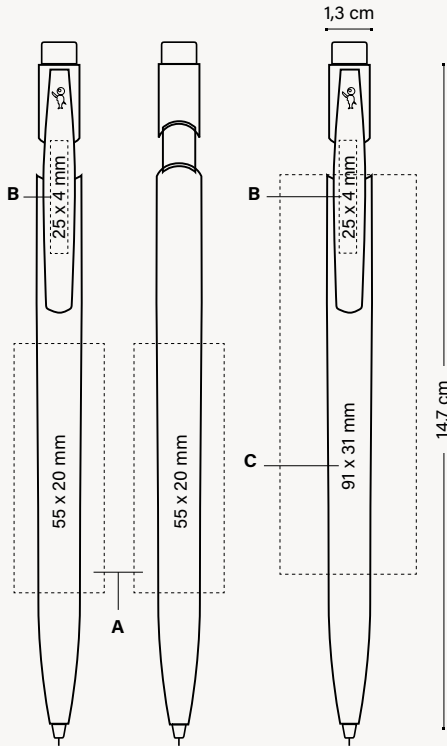

### EMBALLAGE SPÉCIAL EN OPTION

### EXTERNAL PACKAGING



ECO SLEEVE



PLASTIC POUCH



WINDOW BOX



500 ± 4,1 KG

+ INFO PAGES 240 À 245

Peut être utilisé comme marque-page

### EMBALLAGE SPÉCIAL EN OPTION

### EXTERNAL PACKAGING



ECO SLEEVE



PLASTIC POUCH



WINDOW BOX



500 ± 4,3 KG

+ INFO PAGES 240 À 245

Peut être utilisé comme marque-page



FABRIQUÉ ET IMPRIMÉ DANS LES USINES BIC



FABRIQUÉ EN ESPAGNE

### MODES D'ÉCRITURE



PORTE-MINE MP

### TECHNIQUES D'IMPRESSION



SÉRIGRAPHIE



DIGITAL

### DURABILITÉ



PIÈCES AUTOMOBILES EN PLASTIQUE

Consultez les pages 272, 276 pour une explication détaillée des icônes.

INFORMATIONS GÉNÉRALES

EMBALLAGES BIC®

BRIQUETS BIC®/DJEEP® ET ÉTUIS BIC®

CARNETS

AUTRES INSTRUMENTS D'ÉCRITURE

INSTRUMENTS D'ÉCRITURE BIC®

BIC GRAPHIC

## CRAYONS BIC® ET BIC® KIDS EVOLUTION® COLOURING SET

Crayons BIC® et BIC® Kids Evolution® Colouring set.  
Crayons de graphite et de couleur fabriqués en résine synthétique et sans bois, qui ne font pas d'écharde en cas de brisure.

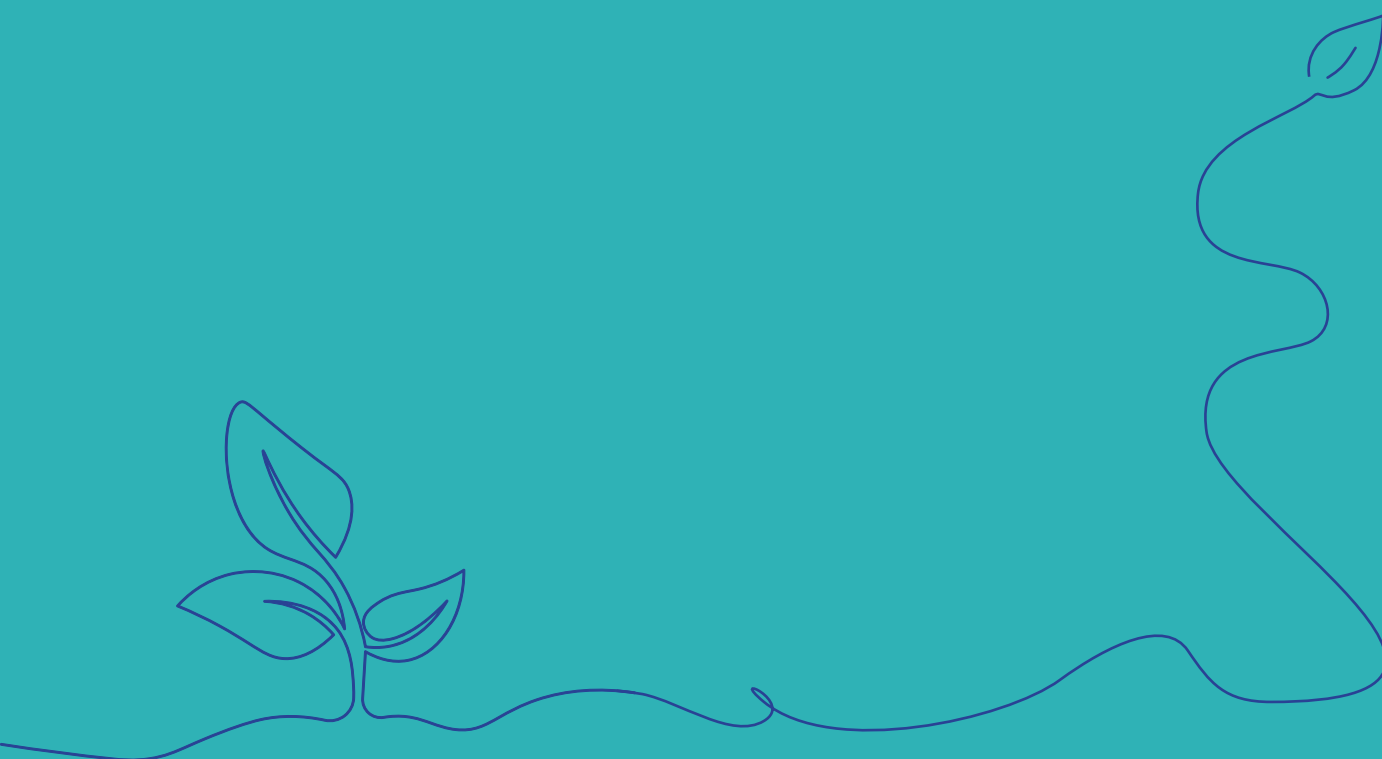

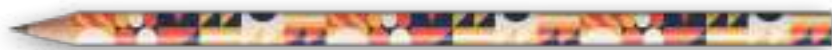

**1150**  
Crayon Ecolutions®  
sans gomme



**1151**  
Crayon Ecolutions®  
avec gomme



**1607**  
BIC® Kids Evolution®  
Colouring set Ecolutions®



**53062**  
Sprout™ Crayon Graphite

Evolution® eColutions®



LA SOLUTION POUR  
UNE COMMUNICATION  
TOUTE EN COULEURS !



LA SOLUTION POUR  
UNE COMMUNICATION  
TOUTE EN COULEURS !



l'icône BIC®  
Boy et logo BIC®  
en relief !



FABRIQUÉ À PARTIR DE  
**64% DE MATÉRIEL RECYCLÉ\***



RÉFRIGÉRATEURS  
ET DE POTS  
DE YAOURTS



FABRIQUÉ À PARTIR DE  
**52% DE MATÉRIEL RECYCLÉ\***



RÉFRIGÉRATEURS  
ET DE POTS  
DE YAOURTS

1150

CRAYON  
SANS GOMME  
eColutions® 1150



impression  
360°



Protecteur  
de mine



20

02

01

échelle 1:1

échelle 1:1

1151

CRAYON  
AVEC GOMME  
eColutions® 1151

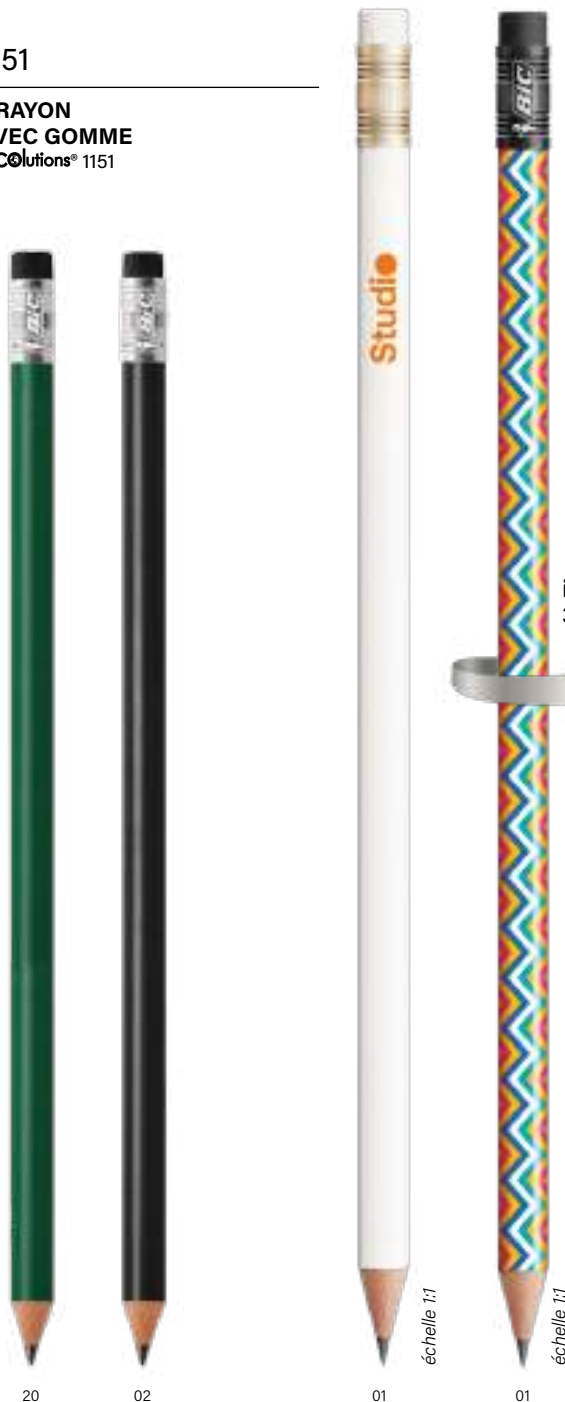

impression  
360°



01

échelle 1:1

01

échelle 1:1

\* Pourcentage calculé sur le poids total du produit. En raison du contenu recyclé des matières premières avec lesquelles le produit est fabriqué, nous ne pouvons pas garantir que les couleurs qui apparaissent dans le catalogue, ni les couleurs personnalisées à la carte, aient toujours la même couleur et la même apparence.



FABRIQUÉ À PARTIR DE **64%**  
DE MATÉRIEL\*\* RECYCLÉ\*



Ajoutez la boucle mobius sur votre BAT sans frais additionnels. Merci de le préciser dans votre bon de commande (en bas à gauche par défaut)

1150 / 1151

**CRAYON AVEC  
ET SANS GOMME**  
1150/1151

**MIX & MATCH**

Sans frais supplémentaires

Commande minimale 500 u.  
Combinaison de couleurs standards

## Gomme

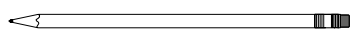

Opaque



## Virole



Opaque



## Corps



Opaque

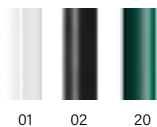

**MIX &  
MATCH**



FABRIQUÉ ET  
IMPRIMÉ DANS  
LES USINES BIC

FABRIQUÉ  
EN FRANCE



RESPECTANT  
LES NORMES



ISO  
certifié



MINE RÉSISTANTE



PAS D'ÉCHARDES  
EN CAS DE BRISURE



PROTECTEUR  
DE MINE



FACILE À UTILISER  
ET À EFFACER

**MODES  
D'ÉCRITURE**



CRAYON PC  
HB 0,2,3MM

**TECHNIQUES  
D'IMPRESSION**



SÉRIGRAPHIE



DIGITAL

**DURABILITÉ**



IMPRIM'VERT®  
ecolutions®

BIC  
GRAPHIC

INSTRUMENTS  
D'ÉCRITURE BIC®

AUTRES INSTRUMENTS  
D'ÉCRITURE

CARNETS

BRIQUETS BIC®/DJEEP®  
ET ÉTUIS BIC®

EMBALLAGES  
BIC®

INFORMATIONS  
GÉNÉRALES

Consultez les pages 272, 276 pour une explication détaillée des icônes.

\*\* Les pourcentages indiqués dans la boucle de Möbius dépendent du produit sélectionné (1150 ou 1151).  
Voir les détails dans la description du produit.



1150

**BIC® EVOLUTION® ECOLUTIONS®**  
**eColutions® 1150** (Crayon sans gomme)

A SP: max. 1 coul.

Commande minimale 500 u.

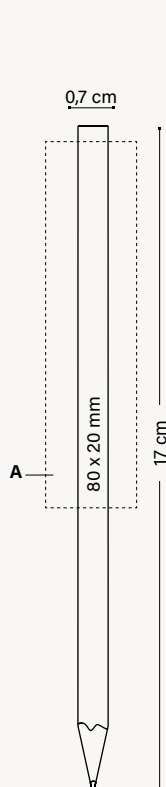

1151

**BIC® EVOLUTION® ECOLUTIONS®**  
**eColutions® 1151** (Crayon avec gomme)

Commande minimale 500 u.

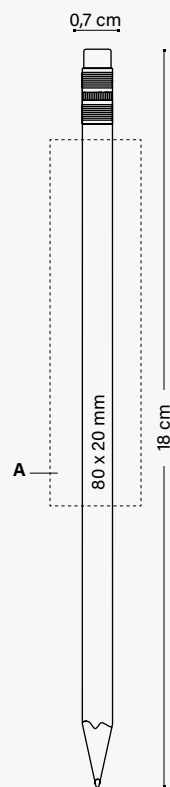

**EMBALLAGE SPÉCIAL EN OPTION**



PLASTIC  
POUCH  
(x 3 UNITÉS)

+ INFO PAGES 240 À 245

*Peut être  
utilisé comme  
marque-page*

**EXTERNAL PACKAGING**



500 ± 3,5 KG

1150

**BIC® EVOLUTION® ECOLUTIONS®**  
**ecolutions®** 1150 (Crayon sans gomme  
 impression numérique)

A DG: Numérique (zone image)  
 Commande minimale 500 u.

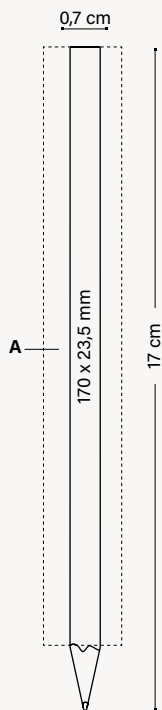

**EMBALLAGE SPÉCIAL EN OPTION**



PLASTIC  
 POUCH  
 (X 3 UNITÉS)

+ INFO PAGES 240 À 245

*Peut être  
 utilisé comme  
 marque-page*

1151

**BIC® EVOLUTION® ECOLUTIONS®**  
**ecolutions®** 1151 (Crayon avec gomme  
 impression numérique)

Commande minimale 500 u.

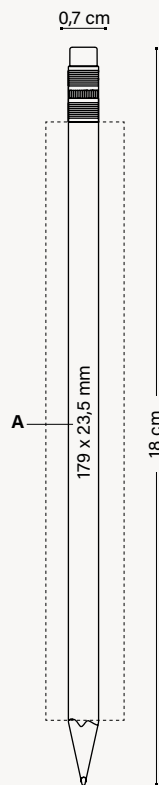

**EXTERNAL PACKAGING**



500 ± 3,5 KG



**MODES D'ÉCRITURE**



**TECHNIQUES D'IMPRESSION**



**DURABILITÉ**



BIC GRAPHIC

INSTRUMENTS D'ÉCRITURE BIC®

AUTRES INSTRUMENTS D'ÉCRITURE

CARNETS

BRIQUETS BIC® / DJEEP® ET ÉTUIS BIC®

EMBALLAGES BIC®

INFORMATIONS GÉNÉRALES

Consultez les pages 272, 276 pour une explication détaillée des icônes.

# BIC® KIDS EVOLUTION® COLOURING SET



Crayons sans bois ultra-résistants et faciles à tailler.  
Idéal pour le dessin et le coloriage au quotidien.



*Utilisation sûre  
pour les enfants*

- Ne se casse pas en éclats
- Résistant à la mastication

*Portefeuille de  
carton entièrement  
personnalisable\*\**



FABRIQUÉ À PARTIR DE  
**51% DE MATÉRIEL RECYCLÉ\***



RÉFRIGÉRATEURS  
ET DE POTS  
DE YAOURTS

1607

**BIC® KIDS EVOLUTION® COLOURING SET**  
**6 UNITÉS**  
eColutions® 1607

**NOUVEAU !**



1609

**BIC® KIDS EVOLUTION® COLOURING SET**  
**12 UNITÉS**  
eColutions® 1609



\* Le pourcentage est calculé sur la base du poids total du crayon, à l'exclusion de la mine.  
\*\* Crayons non personnalisables

# BIC® KIDS EVOLUTION® COLOURING SET

1607

**BIC® KIDS EVOLUTION®  
COLOURING SET**  
eColutions® 1607

A DG: Numérique

Commande minimale 500 u.

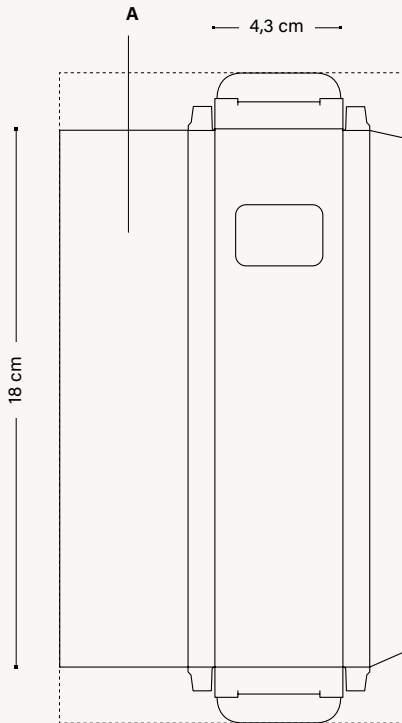

## EMBALLAGE EXTERNE



100 ± 3,74 KG

1609

**BIC® KIDS EVOLUTION® COLOURING SET**  
eColutions® 1609

A DG: Numérique

Commande minimale 500 u.

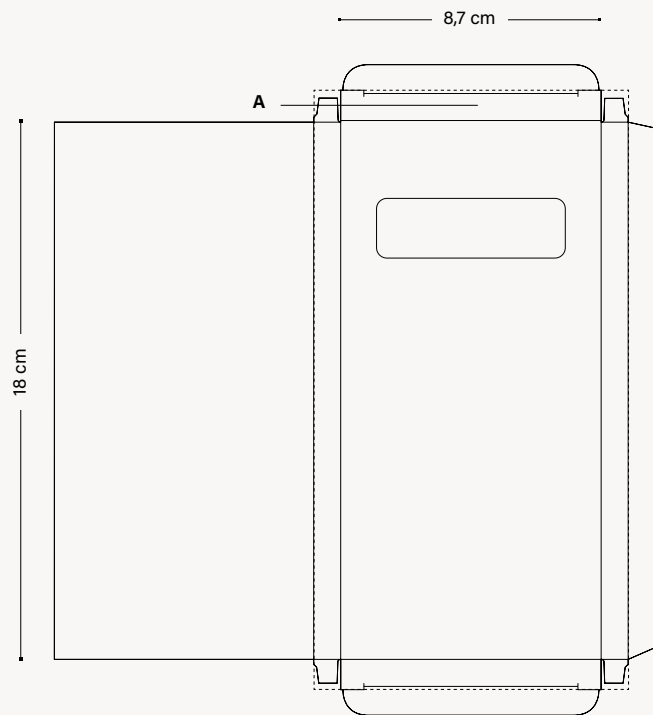

## EMBALLAGE



100 ± 7,35 KG



MODES D'ÉCRITURE

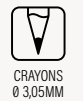

DURABILITÉ



eColutions®



BIC  
GRAPHIC

INSTRUMENTS  
D'ÉCRITURE BIC®

AUTRES INSTRUMENTS  
D'ÉCRITURE

CARNETS

BRIQUETS BIC®/DJEEP®  
ET ÉTUIS BIC®

EMBALLAGES  
BIC®

INFORMATIONS  
GÉNÉRALES

Consultez les pages 272, 276 pour une explication détaillée des icônes.

# SPROUT™ CRAYON GRAPHITE



Le crayon durable que vous pouvez planter après son utilisation et faire pousser des plantes, des légumes, des fruits ou des fleurs.

Ce crayon vous permet de transmettre un message significatif et jette les bases d'une relation durable.

53062

## SPROUT™ CRAYON GRAPHITE

53062

Contient des graines

Plantez après utilisation et faites-le germer.



Corps standard

Corps personnalisé

Carton standard!

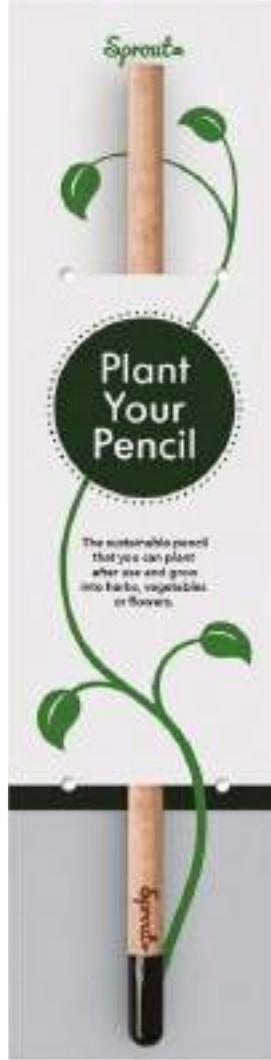

Emballage carton standard

Carton personnalisable!



Emballage carton personnalisé



Arrière



Mine de graphite

Une fois que le crayon est trop court pour écrire, plantez-le et regardez votre message se transformer en un pot de belles herbes, fleurs, fruits ou légumes.

Choisissez parmi 9 graines différentes !



Epicéa



Tournesol



Marguerite



Sauge



Tomate cerise



Myrsotis



Basilic



Thym



Fraise

# SPROUT™ CRAYON GRAPHITE

53062

## SPROUT™ CRAYON GRAPHITE

53062

A LE  
B DG

Commande minimale 100 u.



Un service de taille de crayons est proposé moyennant un supplément.

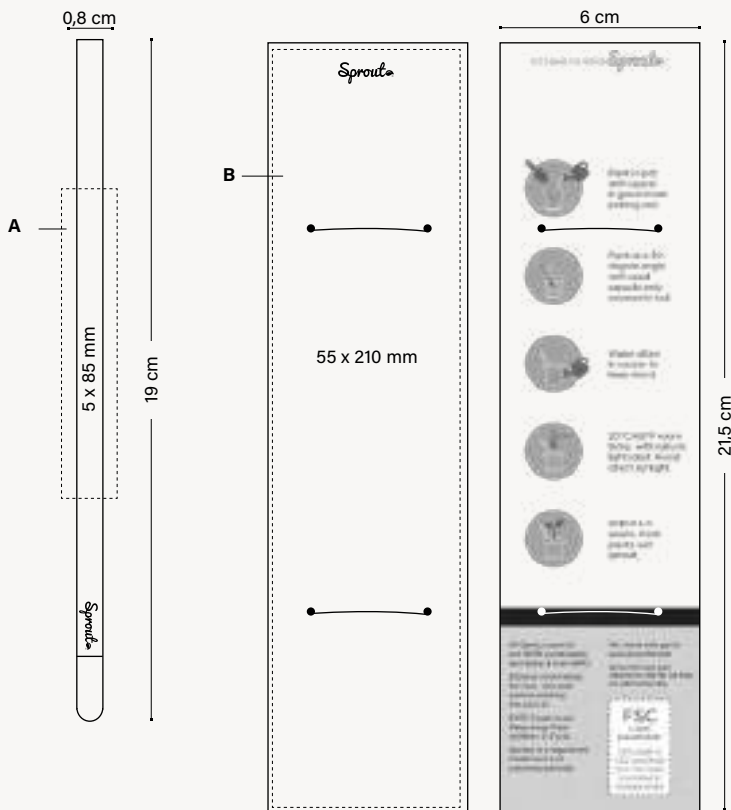

Mode d'emploi inclus au dos. Pour un carton personnalisé, vous pouvez changer la police et les couleurs.

### EMBALLAGE EXTERNE



Sprout™ Graphite Pencil sans emballage carton:

500 ± 2,37 KG

Sprout™ Graphite Pencil avec emballage carton:

100 ± 0,92 KG

### EMBALLAGE



Sprout



MODES D'ÉCRITURE



CRAYON PC HB  
Ø 2,3MM

TECHNIQUES D'IMPRESSION



LASER



DIGITAL

DURABILITÉ



FSC ET CARTON RECYCLABLE



REGARDEZ LA VIDEO

Veuillez consulter votre représentant commercial pour plus de détails sur les langues disponibles.

Consultez les pages 272-276 pour une explication détaillée des icônes.



# AUTRES INSTRUMENTS D'ÉCRITURE

---

# 02

## PLASTIC PENS

---

### Fiabilité au quotidien, style sans effort.

Notre collection de stylos en plastique allie fonctionnalité, confort et design moderne. Légers mais résistants. Choisissez parmi une large gamme de couleurs et de finitions pour trouver celui qui correspond parfaitement à votre marque ou à votre style personnel.



**12010**  
Basic Pen



**11748**  
Click Pen



**11243**  
Striped Grip Pen

Choix simple  
et pratique

# BASIC PEN

---

12010

**BASIC PEN**  
12010

Couleur d'encre



# BASIC PEN

12010

**BASIC PEN**  
12010

A/B SP: max. 1 coul.

Commande minimale 500 u.

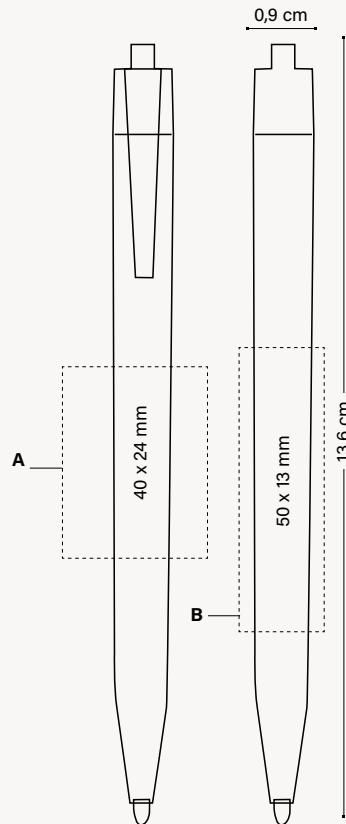

## EMBALLAGE EXTERNE



1000 ± 12,5 KG



IMPRIMÉ DANS  
LES USINES BIC



QUALITÉ ET SÉCURITÉ  
APPROUVÉES



RESPECTANT  
LES NORMES



ISO  
certified

MODES  
D'ÉCRITURE



BILLE M  
Ø 1 MM

TECHNIQUES  
D'IMPRESSION



SÉRIGRAPHIE

DURABILITÉ



IMPRIM'VERT®

BIC  
GRAPHIC

INSTRUMENTS  
D'ÉCRITURE BIC®

AUTRES INSTRUMENTS  
D'ÉCRITURE

CARNETS

BRIQUETS BIC®/DJEEP®  
ET ÉTUIS BIC®

EMBALLAGES  
BIC®

INFORMATIONS  
GÉNÉRALES

Consultez les pages 272-276 pour une explication détaillée des icônes.

# CLICK PEN

---

11748

## CLICK PEN

11748

Couleur d'encre



# CLICK PEN

11748

## CLICK PEN

11748

A/B SP: max. 4 coul.

C/D PD: max. 4 coul.

Commande minimale 500 u.

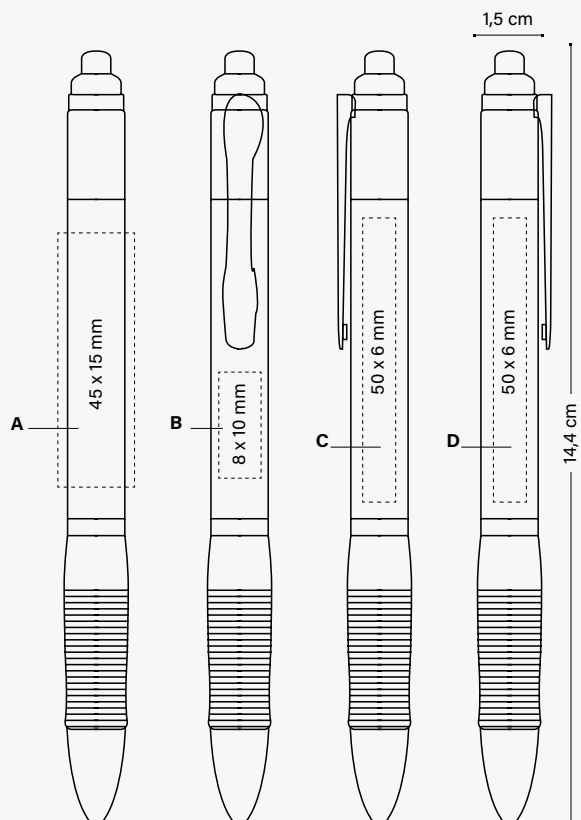

### EMBALLAGE EXTERNE



1000 ± 9,5 KG



IMPRIMÉ DANS  
LES USINES BIC



QUALITÉ ET SÉCURITÉ  
APPROUVÉES



RESPECTANT  
LES NORMES



ISO  
certified

### MODES D'ÉCRITURE



BILLE M  
Ø 1 MM

### TECHNIQUES D'IMPRESSION



SP  
SÉRIGRAPHIE



PD  
TAMPOGRAPHIE

### DURABILITÉ



IMPRIM'VERT®

BIC  
GRAPHIC

INSTRUMENTS  
D'ÉCRITURE BIC®

AUTRES INSTRUMENTS  
D'ÉCRITURE

CARNETS

BRIQUETS BIC®/DJEEP®  
ET ÉTUIS BIC®

EMBALLAGES  
BIC®

INFORMATIONS  
GÉNÉRALES

Consultez les pages 272, 276 pour une explication détaillée des icônes.

# STRIPED GRIP PEN

---

11243

## STRIPED GRIP PEN

11243

Couleur d'encre



10



03



24



8C



04

échelle 1:1

# STRIPED GRIP PEN

11243

## STRIPED GRIP PEN

11243

A SP: max. 2 coul.

B PD: max. 1 coul.

Commande minimale 500 u.

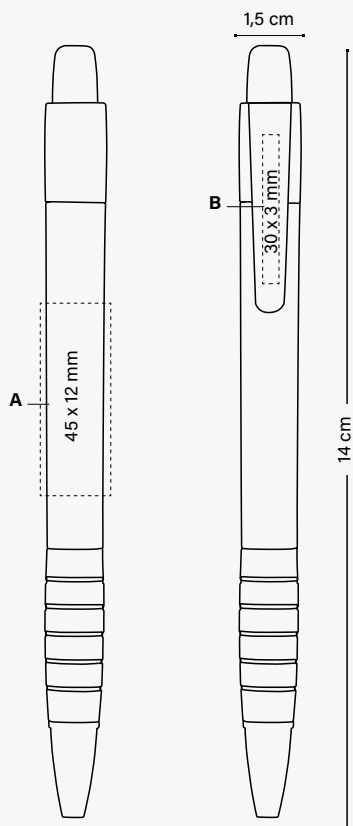

### EMBALLAGE EXTERNE



### MODES D'ÉCRITURE



### TECHNIQUES D'IMPRESSION



### DURABILITÉ



BIC GRAPHIC

INSTRUMENTS D'ÉCRITURE BIC®

AUTRES INSTRUMENTS D'ÉCRITURE

CARNETS

BRIQUETS BIC®/DJEEP® ET ÉTUIS BIC®

EMBALLAGES BIC®

INFORMATIONS GÉNÉRALES

Consultez les pages 272-276 pour une explication détaillée des icônes.

# SLEEK STYLUS PEN

---

Un stylo pour chaque  
moment professionnel.

Une écriture assurée pour chaque signature.

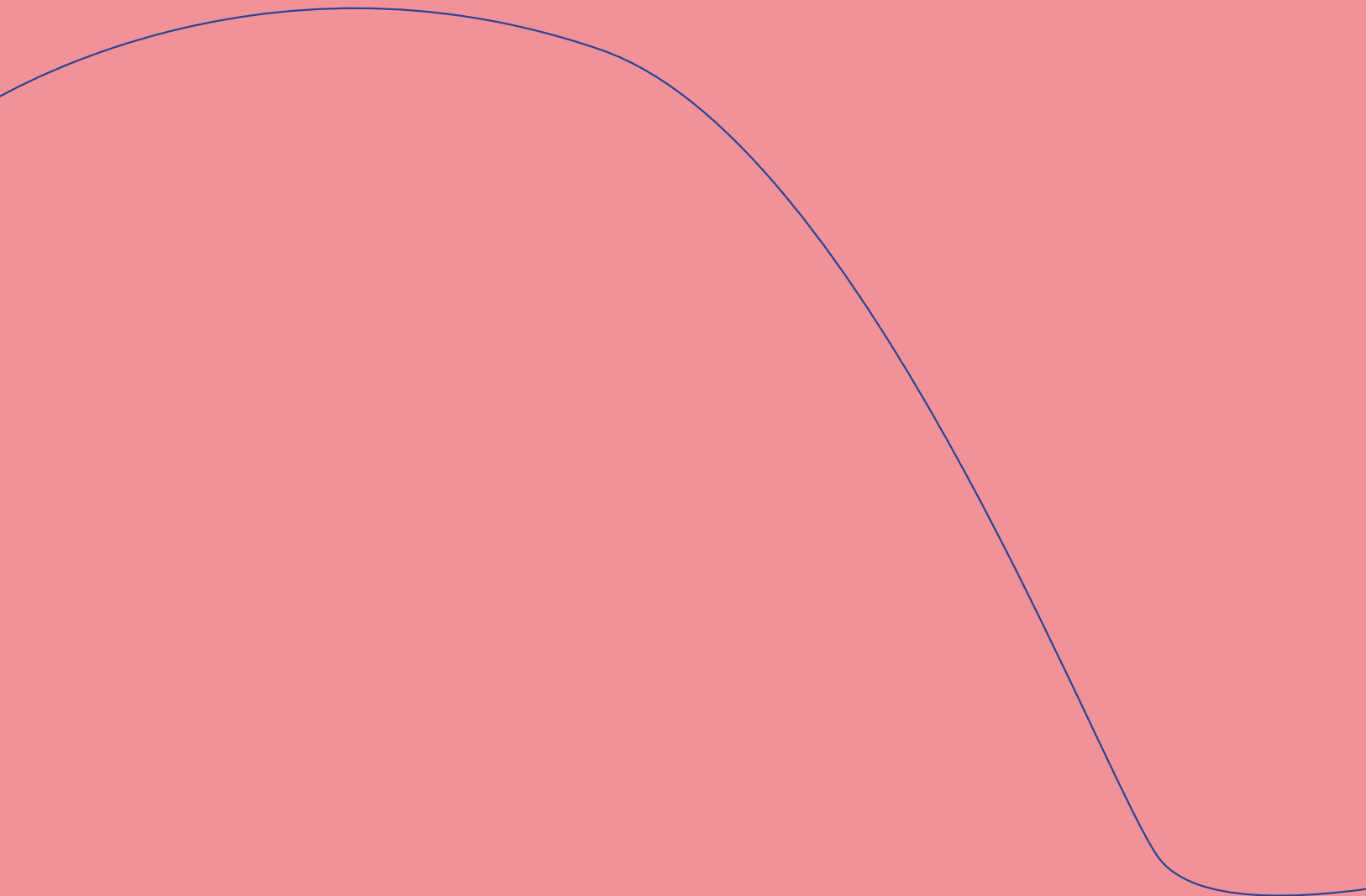



**11666**  
Sleek Stylus Pen



**11747**  
Sleek Stylus  
Matt Pen



**11976**  
Sleek Stylus  
Executive Pen

Écrivez avec audace

# SLEEK STYLUS PEN

---

11666

## SLEEK STYLUS PEN

11666

Couleur d'encre



échelle 1:1

01

11747

## SLEEK STYLUS MATT PEN

11747

Couleur d'encre



47



échelle 1:1

04

11976

## SLEEK STYLUS EXECUTIVE PEN

11976



26

●  
Disponible en  
encre bleue



2N

●  
Disponible en  
encre noire

# SLEEK STYLUS PEN

11666 / 11747 / 11976

## SLEEK STYLUS PEN

11666

## SLEEK STYLUS MATT PEN

11747

## SLEEK STYLUS EXECUTIVE PEN

11976

**A SP:** max. 1 coul.

**B SP:** max. 2 coul.

**C LE**

Commande minimale 500 u. (SP)

Commande minimale 100 u. (LE)

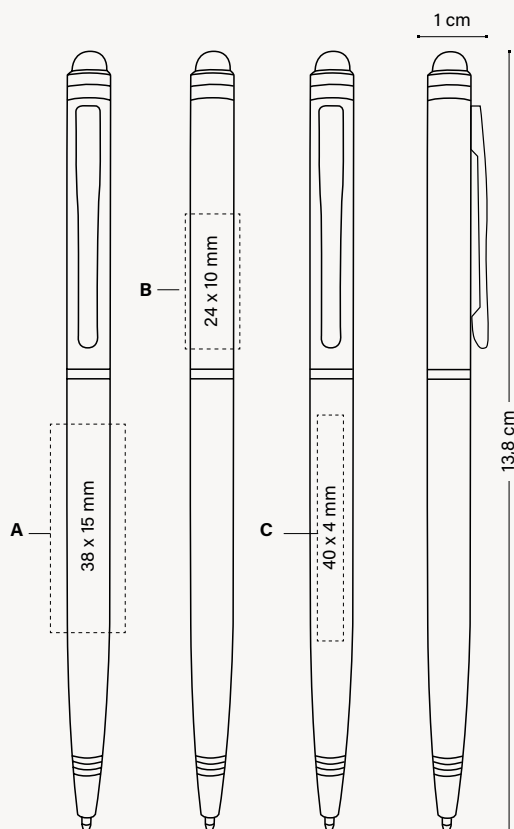

### EMBALLAGE EXTERNE



(11666)  
900 ± 12,4 KG



(11747 / 11976)  
800 ± 13 KG



### MODES D'ÉCRITURE



### TECHNIQUES D'IMPRESSION



### DURABILITÉ



BIC GRAPHIC

INSTRUMENTS D'ÉCRITURE BIC®

AUTRES INSTRUMENTS D'ÉCRITURE

CARNETS

BRIQUETS BIC®/DJEEP® ET ÉTUIS BIC®

EMBALLAGES BIC®

INFORMATIONS GÉNÉRALES

Consultez les pages 272, 276 pour une explication détaillée des icônes.



# CARNETS

---

# 03



BIC® PARTNER : un carnet de haute qualité, fabriqué en Italie, qui vous accompagne partout où vos idées vous mènent.

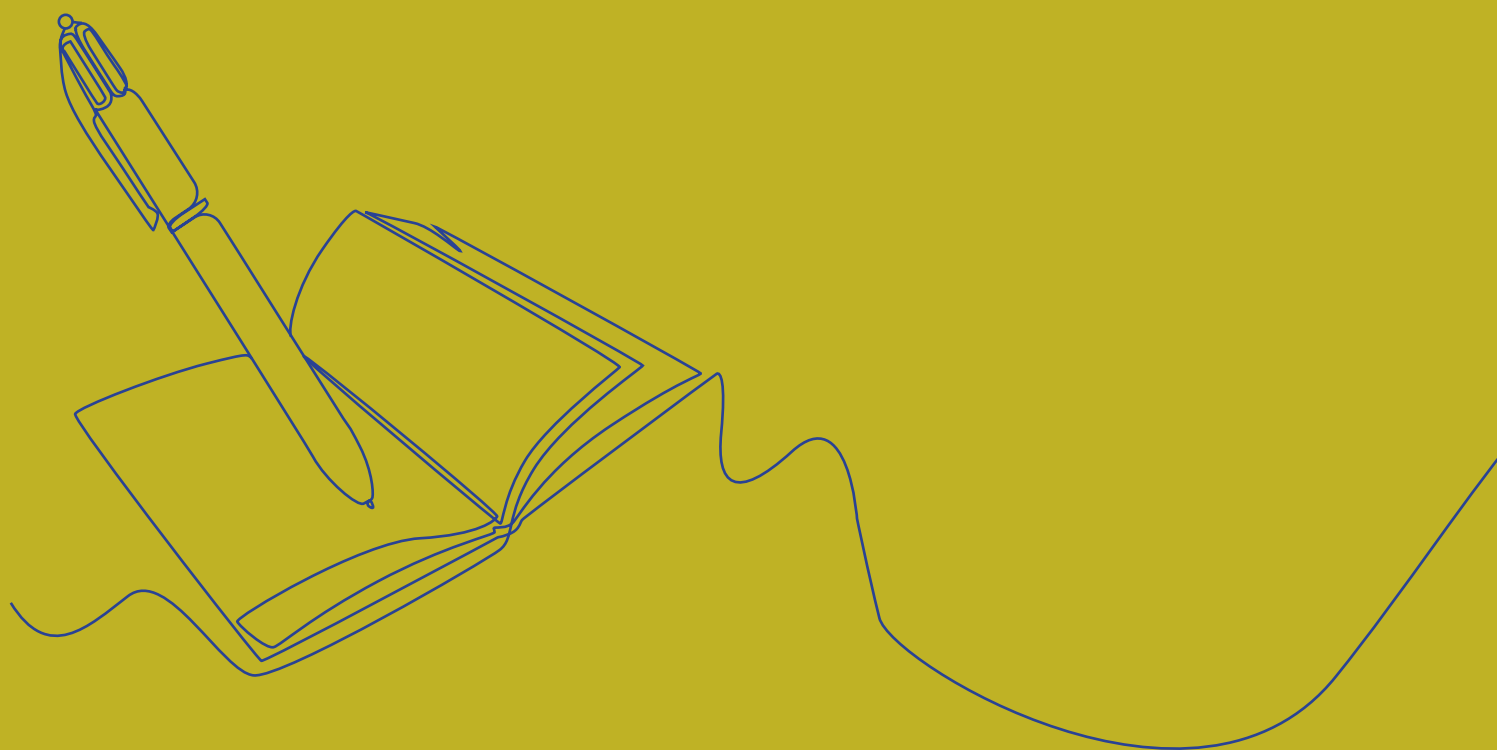



**3709**  
BIC® Partner Hard Cover\*



**3710**  
BIC® Partner Flex Cover\*



**3711**  
BIC® Partner FruitCover\*

\* Stylo non inclus.

3709

BIC® PARTNER HARD COVER  
3709

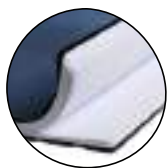

Équipé d'un système Quickview permettant une consultation facile.

DIN A5  
72 feuilles / 144 pages



01  
Blanc



02  
Noir



07  
Bleu marine



03  
Rouge



Papier de haute qualité,  
recyclé et certifié FSC.



Fermeture  
élastique.



Poche  
intérieure.

Stylo non inclus.

# BIC® PARTNER HARD COVER

3709

## BIC® PARTNER HARD COVER

3709

**A SP:** max. 1 coul.

**B BP:** Numérique

**C/D HS/DB:** max. 1 coul.

Commande minimale 25 u.

BIC® Partner Hard Cover contient du papier blanc certifié FSC, 80 g/m<sup>2</sup>, sans revêtement artificiel, fabriqué à partir de cellulose d'eucalyptus à fibres courtes et d'une très haute blancheur.

 PAPIER À LIGNES

● Noir ● Bleu ○ Blanc ● Rouge

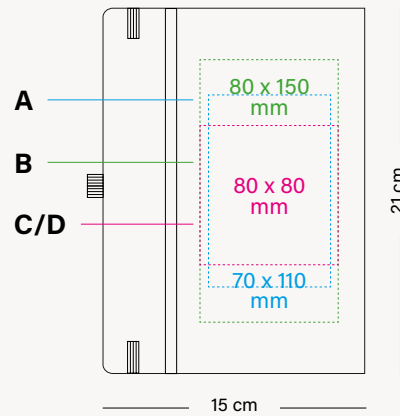
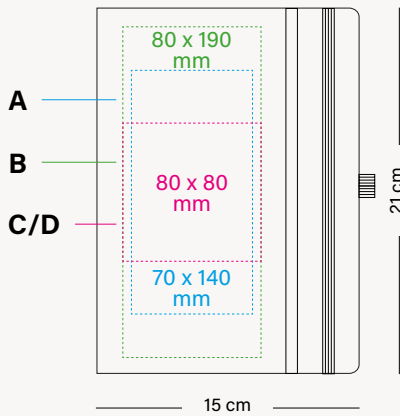

### EMBALLAGE EXTERNE



Porte-stylo.

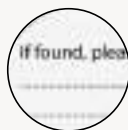

"En cas de perte, veuillez retourner à" imprimé en anglais sur la 1ère page.



Brochure descriptive



IMPRIMÉ DANS  
LES USINES BIC



FABRIQUÉ EN ITALIE



TECHNIQUES  
D'IMPRESSION



SÉRIGRAPHIE



BRITEPIX™



HOT STAMPING



DEBOSSING

DURABILITÉ



FSC ET CARTON  
RECYCLABLE

BIC  
GRAPHIC

INSTRUMENTS  
D'ÉCRITURE BIC®

AUTRES INSTRUMENTS  
D'ÉCRITURE

CARNETS

BRIQUETS BIC®/DJEEP®  
ET ÉTUIS BIC®

EMBALLAGES  
BIC®

INFORMATIONS  
GÉNÉRALES

Consultez les pages 272, 276 pour une explication détaillée des icônes.

# BIC® PARTNER FLEX COVER



3710

BIC® PARTNER FLEX COVER  
3710



Finition Soft-Touch au toucher.

DIN A5  
72 feuilles / 144 pages



02  
Noir



03  
Rouge



07  
Bleu marine



Papier de haute qualité,  
recyclé et certifié FSC.



Fermeture  
élastique.



Poche  
intérieure.

Stylo non inclus.

# BIC® PARTNER FLEX COVER

3710

## BIC® PARTNER FLEX COVER

3710

**A SP:** max. 1 coul.

**B HS:** max. 1 coul.

**C DB:** max. 1 coul.

Commande minimale 25 u.

BIC® Partner Flex Cover contient du papier blanc certifié FSC, 80 g/m<sup>2</sup>, sans revêtement artificiel, fabriqué à partir de cellulose d'eucalyptus, fibres courtes, d'une très haute blancheur.



PAPIER À LIGNES



Noir



Bleu



Rouge

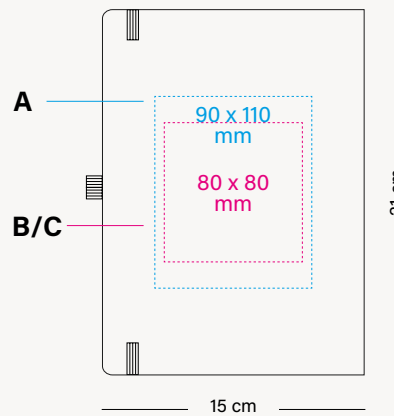
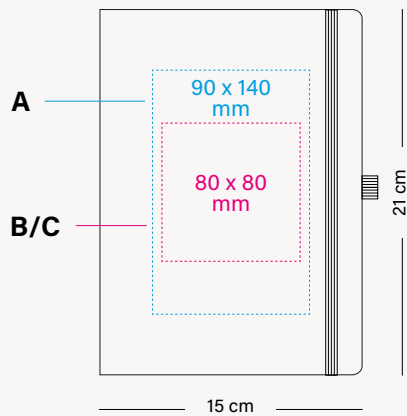

### EMBALLAGE EXTERNE



25 ± 9,7 KG



Porte-stylo.



"En cas de perte, veuillez retourner à" imprimé en anglais sur la 1ère page.



Brochure descriptive



IMPRIMÉ DANS  
LES USINES BIC



FABRIQUÉ EN ITALIE



ISO  
certified

TECHNIQUES  
D'IMPRESSION



SP

SÉRIGRAPHIE



HS

HOT STAMPING



DB

DEBOSSING

DURABILITÉ



FSC ET CARTON  
RECYCLABLE

BIC  
GRAPHIC

INSTRUMENTS  
D'ÉCRITURE BIC®

AUTRES INSTRUMENTS  
D'ÉCRITURE

CARNETS

BRIQUETS BIC®/DJEEP®  
ET ÉTUIS BIC®

EMBALLAGES  
BIC®

INFORMATIONS  
GÉNÉRALES

Consultez les pages 272-276 pour une explication détaillée des icônes.

3711

BIC® PARTNER FRUITCOVER  
3711



La couverture est fabriquée à partir de 39% de déchets de pommes.

DIN A5  
72 feuilles / 144 pages



10  
Sable jaune



59  
Vert Pomme



06  
Pierre grise



Papier de haute qualité,  
recyclé et certifié FSC.



Fermeture  
élastique.



Poche  
intérieure.

Stylo non inclus.

# BIC® PARTNER FRUITCOVER

3711

## BIC® PARTNER FRUITCOVER

3711

**A SP:** max. 1 coul.

**B HS:** max. 1 coul.

**C DB:** max. 1 coul.

Commande minimale 25 u.

BIC® Partner FruitCover contient du papier recyclé de couleur ivoire, avec certification FSC, 80 g/m<sup>2</sup>.



PAPIER À LIGNES



Vert Pomme



Pierre grise



Sable jaune

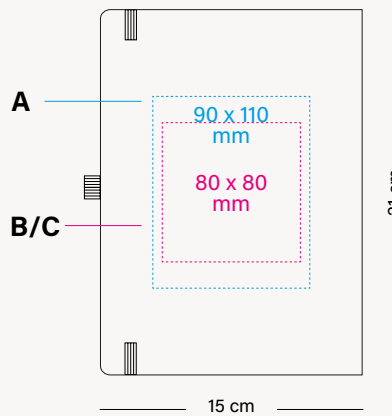
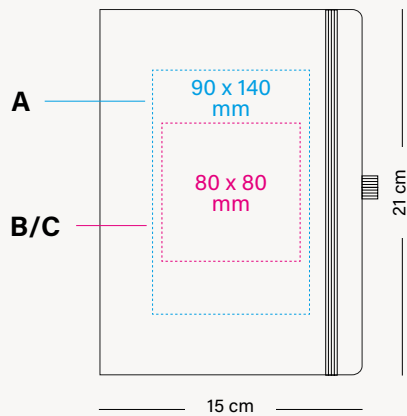

### EMBALLAGE EXTERNE



Porte-stylo.

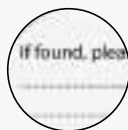

“En cas de perte, veuillez retourner à” imprimé en anglais sur la 1ère page.



Brochure descriptive



IMPRIMÉ DANS  
LES USINES BIC



FABRIQUÉ EN ITALIE



TECHNIQUES  
D'IMPRESSION



SÉRIGRAPHIE



HOT STAMPING



DEBOSSING

DURABILITÉ



FSC ET CARTON  
RECYCLABLE

BIC  
GRAPHIC

INSTRUMENTS  
D'ÉCRITURE BIC®

AUTRES INSTRUMENTS  
D'ÉCRITURE

CARNETS

BRIQUETS BIC®/DJEEP®  
ET ÉTUIS BIC®

EMBALLAGES  
BIC®

INFORMATIONS  
GÉNÉRALES

Consultez les pages 272-276 pour une explication détaillée des icônes.

## CARNETS BIC® PARTNER

---

Personnalisez votre carnet BIC® Partner avec  
notre NOUVEAU SERVICE SUR MESURE



**Choisissez votre  
couleur — même  
le Pantone !**

---

**Disponible avec :**  
BIC® Partner Hard Cover

**Digital Art Paper, couverture  
entièrement imprimée à l'avant et à  
l'arrière, sur 100 % de la surface.**

---

**Disponible avec :**  
BIC® Partner Hard Cover

**Personnalisez  
les pages  
intérieures**

---

**Disponible avec :**  
BIC® Partner Hard Cover  
BIC® Partner Flex Cover  
BIC® Partner Fruitcover

 Fabriqué  
en Italie



Contactez votre représentant commercial pour plus d'informations.

Stylo non inclus.





**BRIQUETS**

**BIC<sup>®</sup> / DJEEP<sup>®</sup>**

**ET ÉTUIS BIC<sup>®</sup>**

---

**04**

## BRIQUETS BIC®

---

Le célèbre briquet BIC®, une icône indémodable, avec un design toujours tendance !

Cinq modèles différents et une large gamme de combinaisons de couleurs.

Illuminez - le



# FAMILLE BRIQUETS BIC®



**2360**  
BIC® J25 Briquet  
Sérigraphie



**2360**  
BIC® J25 Briquet  
Impression digitale



**2340**  
BIC® J23 Briquet  
Sérigraphie



**2340**  
BIC® J23 Briquet  
Impression digitale



**2320**  
BIC® J26 Briquet  
Sérigraphie



**2320**  
BIC® J26 Briquet  
Impression digitale



**2452**  
BIC® J38 Briquet  
Sérigraphie



**2452**  
BIC® J38 Briquet  
Impression digitale



**2450**  
BIC® EZ Reach™ Briquet  
Sérigraphie



**2450**  
BIC® EZ Reach™ Briquet  
Impression digitale

BIC  
GRAPHIC

INSTRUMENTS  
D'ÉCRITURE BIC®

AUTRES INSTRUMENTS  
D'ÉCRITURE

CARNETS

BRIQUETS BIC® / DJEEP®  
ET ÉTUIS BIC®

EMBALLAGES  
BIC®

INFORMATIONS  
GÉNÉRALES

# BIC® est le numéro un mondial des briquets de marque.

Tous les briquets BIC® respectent ou dépassent les exigences des normes et réglementations internationales (ISO 9994, EN 13869, ASTM F400, US CPSC).  
Ne prenez pas de risque, achetez un briquet BIC® !



**BIC® est le numéro un mondial des briquets de marque.\***

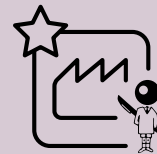

**100% des briquets sont fabriqués par BIC® en Europe. Tous les briquets BIC® sont fabriqués dans les usines de BIC. C'est le point de départ de la garantie de sécurité des briquets BIC®.**

**50  
ANS**

BIC® a acquis 50 ans d'une incroyable expertise de fabrication afin de garantir la sécurité et la qualité de ses produits.

**50  
CONTRÔLES**

Avant de quitter l'usine, chaque briquet BIC® subit plus de 50 contrôles automatiques de qualité et de sécurité.



Avec comme garantie nos plus de 50 ans d'expérience !



SP

**Sérigraphie**

Une technique parfaite pour créer des impressions de qualité et les correspondances de couleurs.



BR

**Brilliant**

Choisissez la finition brillante pour un effet final éblouissant.



MT

**Matt**

La finition mate permet d'ajouter une touche d'élégance à votre design.



M

**Metallic**

Créez de superbes effets ! Effets métalliques sur les textes, les images et le fond.



H

**Holographic**

Démarquez-vous de la concurrence ! Jouez avec les reflets dorés ou argentés dans votre design.



P

**Puffy**

Personnalisation mise en évidence qui donne un effet de relief à votre logo.

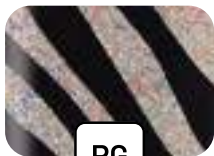

PG

**Puffy Glitter**

Embellissez vos designs avec l'effet scintillant des paillettes. Voyez et sentez sa texture pailletée et colorée.



UV

**UV**

Faites ressortir votre marque avec une finition très brillante ! Associez une finition mate et une finition brillante pour souligner les contrastes.



BP

**BritePix™ Digital**

La solution pour une communication tout en couleur. Maintenant sur des corps en couleur !



Finitions des briquets BIC®

# Parfait pour votre poche !

2360 / 2364

**BIC® J25 BRIQUET**  
2360  
2364 All Black



*l'iconique BIC® Boy  
et le logo BIC® gravé !*



01

57

57

8G

03

11

59

24



25

25

6W

02

02

02

02

échelle 1:1

# BIC® J25 BRIQUET

2360/2364

## BIC® J25 BRIQUET

2360/2364

A/C SP: max. 4 coul.

Commande minimale 300 u.

2360/2364

## BIC® J25 BRIQUET BRITEPIX™

2360 / 2364

A/C BP: Numérique

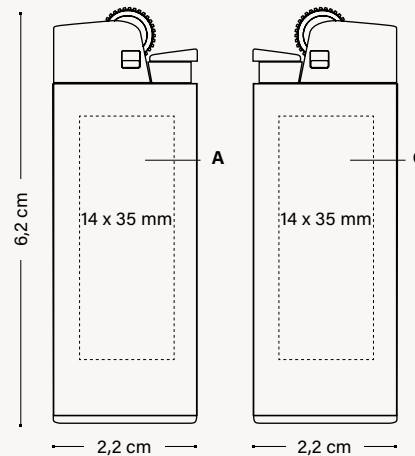
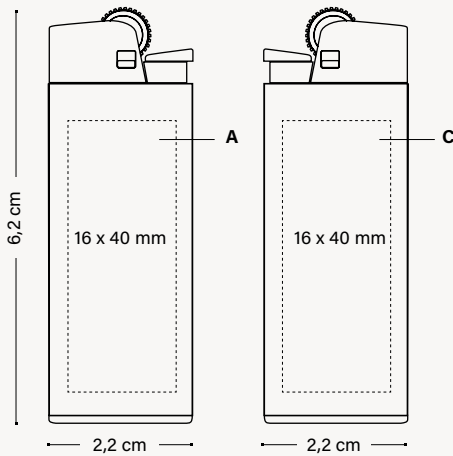

### EMBALLAGE



100% recyclé !

EMBALLAGE STANDARD :  
BARQUETTE DE 50 UNITÉS

### EMBALLAGE EXTERNE



600 ± 76 KG



FSC ET CARTON  
RECYCLABLE

### EMBALLAGE INTÉRIEUR OPTIONNEL

0087

COUNT BOX 10U. ÉTUIS



0088

COUNT BOX 10U.  
ÉTUIS CHILD RESISTANT



0086

COUNT BOX 10U.  
J25 CHILD RESISTANT



FABRIQUÉ ET  
IMPRIMÉ DANS  
LES USINES BIC



FABRIQUÉ  
EN ESPAGNE



RESPECTANT  
LES NORMES



JUSQU'À 1.450



Conform  
ISO 9994



Conform  
EN 13869 85%

### TECHNIQUES D'IMPRESSION



SÉRIGRAPHIE



BRITEPIX™

### DURABILITÉ



IMPRIM'VERT®



100 % DE L'ÉLECTRICITÉ  
PROVIENT DE SOURCES  
RENOUVELABLES



REGARDEZ LA VIDEO

Consultez les pages 272-276 pour une explication détaillée des icônes.

FINITIONS NUMÉRIQUES



**BR** BRILLIANT



**MT** MATT

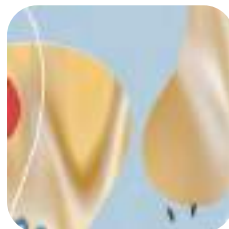

**H** HOLOGRAPHIC SILVER GOLD



**P** PUFFY



**M** METALLIC



**UV** UV



**PG** PUFFY GLITTER

2360

BIC® J25 BRIQUET  
2360



**MT** MATT

**P** PUFFY



**PG** PUFFY GLITTER



impression  
360°

échelle 1:1

**MT** MATT

**M** METALLIC

# BIC® J25 BRIQUET

2360

**BIC® J25 BRIQUET**

2360

**A DG:** Numérique

Commande minimale 600 u.

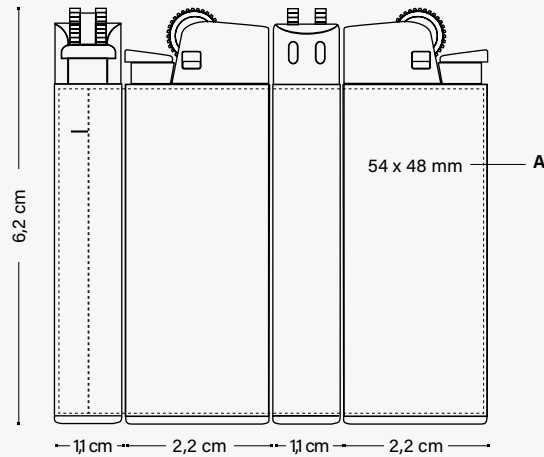

FABRIQUÉ ET  
IMPRIMÉ DANS  
LES USINES BIC



FABRIQUÉ  
EN ESPAGNE



RESPECTANT  
LES NORMES



JUSQU'À 1.450



Conform  
EN 13869 85%

TECHNIQUES  
D'IMPRESSION



DIGITAL

DURABILITÉ



100 % DE L'ÉLECTRICITÉ  
PROVIENT DE SOURCES  
RENOUVELABLES

## EMBALLAGE



100% recyclé !

EMBALLAGE STANDARD :  
BARQUETTE DE 50 UNITÉS

## EMBALLAGE EXTERNE



600 ± 76 KG



FSC ET CARTON  
RECYCLABLE

## EMBALLAGE INTÉRIEUR OPTIONNEL

0087

COUNT BOX 10U. ÉTUIS



0088

COUNT BOX 10U.  
ÉTUIS CHILD RESISTANT



0086

COUNT BOX 10U.  
J25 CHILD RESISTANT



REGARDEZ LA VIDEO

Consultez les pages 272, 276 pour une explication détaillée des icônes.

**BIC® J23 BRIQUET**



*l'icône BIC® Boy  
et le logo BIC® gravé !*

**2340**

**BIC® J23 BRIQUET**  
2340



57



12



03



10

*Fin et élégant,  
il se glisse partout !*



échelle 1:1



05



04



25



02

# BIC® J23 BRIQUET

2340

**BIC® J23 BRIQUET**

2340

A/C SP: max. 4 coul.

Commande minimale 300 u.

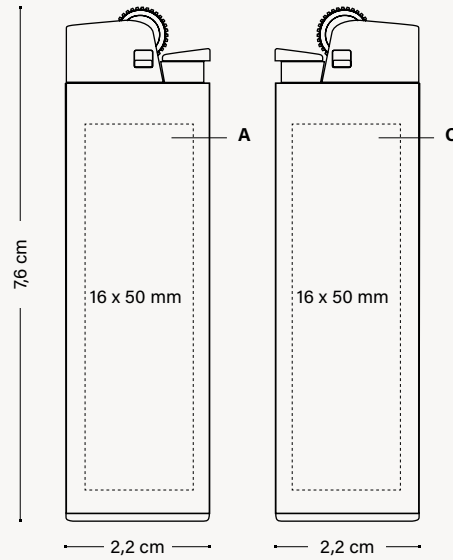

TECHNIQUES D'IMPRESSION



DURABILITÉ



## EMBALLAGE



100% recyclé !

EMBALLAGE STANDARD :  
BARQUETTE DE 50 UNITÉS

## EMBALLAGE EXTERNE



600 ± 9,5 KG



FSC ET CARTON  
RECYCLABLE

## EMBALLAGE INTÉRIEUR OPTIONNEL

0087

COUNT BOX 10U. ÉTUIS



0088

COUNT BOX 10U.  
ÉTUIS CHILD RESISTANT



REGARDEZ LA VIDEO

Consultez les pages 272-276 pour une explication détaillée des icônes.

FINITIONS NUMÉRIQUES



**BR** BRILLIANT



**MT** MATT



**H** HOLOGRAPHIC SILVER GOLD



**P** PUFFY



**M** METALLIC



**UV** UV



**PG** PUFFY GLITTER

2340

BIC® J23 BRIQUET  
2340



**MT** MATT



**PG** PUFFY GLITTER



impression  
360°

échelle 1:1

**BR** BRILLIANT

**H** HOLOGRAPHIC GOLD

# BIC® J23 BRIQUET

2340

**BIC® J23 BRIQUET**

2340

**A DG:** Numérique

Commande minimale 600 u.

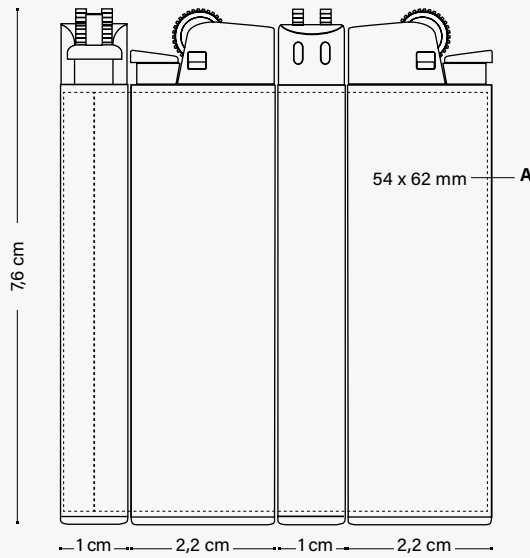

TECHNIQUES D'IMPRESSION



## EMBALLAGE



100% recyclé !

EMBALLAGE STANDARD :  
BARQUETTE DE 50 UNITÉS

## EMBALLAGE EXTERNE



600 ± 9,5 KG



FSC ET CARTON  
RECYCLABLE

## EMBALLAGE INTÉRIEUR OPTIONNEL

0087

COUNT BOX 10U. ÉTUIS



0088

COUNT BOX 10U.  
ÉTUIS CHILD RESISTANT



REGARDEZ LA VIDEO

Consultez les pages 272-276 pour une explication détaillée des icônes.

# La flamme qui dure.



*l'icône BIC® Boy  
et le logo BIC® gravé !*

2320

**BIC® J26 BRIQUET**  
2320



01



57



8G



10B



6W

*Longue durée:  
jusqu'à 3.000  
allumages !*



échelle 1:1



59



24



25



02

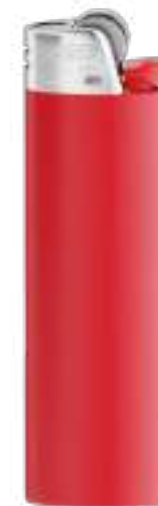

03

# BIC® J26 BRIQUET

2320

**BIC® J26 BRIQUET**

2320

A/C SP: max. 4 coul.

Commande minimale 300 u.

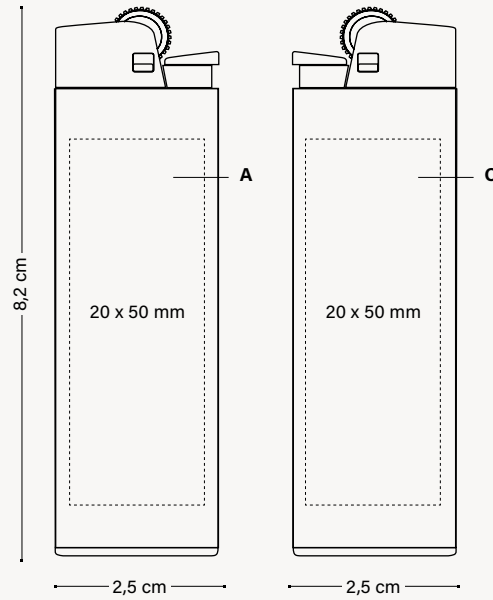

## EMBALLAGE



100% recyclé !

EMBALLAGE STANDARD :  
BARQUETTE DE 50 UNITÉS

## EMBALLAGE EXTERNE



600 ± 15,1 KG



FSC ET CARTON  
RECYCLABLE

## EMBALLAGE INTÉRIEUR OPTIONNEL

0087

COUNT BOX 10U. ÉTUIS



0088

COUNT BOX 10U.  
ÉTUIS CHILD RESISTANT



FABRIQUÉ ET  
IMPRIMÉ DANS  
LES USINES BIC



FABRIQUÉ  
EN ESPAGNE



RESPECTANT  
LES NORMES



IUSQU'À 3.000



TECHNIQUES  
D'IMPRESSION



SÉRIGRAPHIE

DURABILITÉ



IMPRIM'VERT®



100 % DE L'ÉLECTRICITÉ  
PROVIENT DE SOURCES  
RENOUVELABLES



REGARDEZ LA VIDEO

Consultez les pages 272-276 pour une explication détaillée des icônes.

FINITIONS NUMÉRIQUES



BR BRILLIANT



MT MATT



H HOLOGRAPHIC SILVER GOLD



P PUFFY



M METALLIC



UV UV



PG PUFFY GLITTER

2320

BIC® J26 BRIQUET  
2320



MT MATT



BR BRILLIANT



MT MATT

impression 360°

échelle 1:1

# BIC® J26 BRIQUET

2320

**BIC® J26 BRIQUET**

2320

**A DG:** Numérique

Commande minimale 600 u.

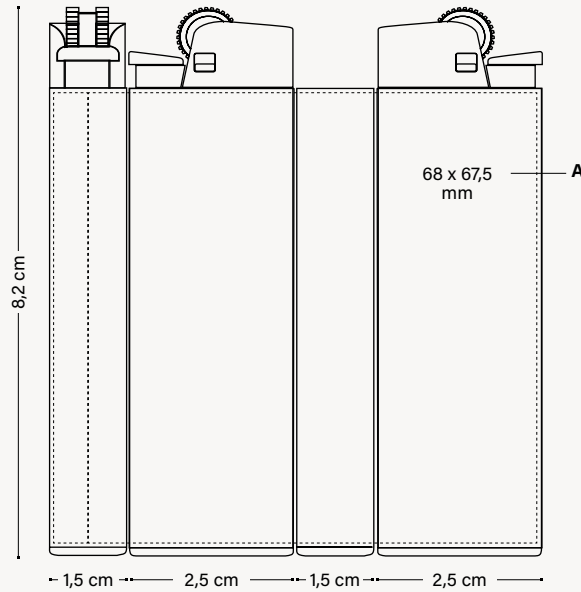

FABRIQUÉ ET  
IMPRIMÉ DANS  
LES USINES BIC



FABRIQUÉ  
EN ESPAGNE



RESPECTANT  
LES NORMES



JUSQU'À 3.000



TECHNIQUES  
D'IMPRESSION



DIGITAL

DURABILITÉ



100 % DE L'ÉLECTRICITÉ  
PROVIENT DE SOURCES  
RENOUVELABLES

## EMBALLAGE



100% recyclé !

EMBALLAGE STANDARD :  
BARQUETTE DE 50 UNITÉS

## EMBALLAGE EXTERNE



600 ± 15,1 KG



FSC ET CARTON  
RECYCLABLE

## EMBALLAGE INTÉRIEUR OPTIONNEL

0087

COUNT BOX 10U. ÉTUIS



0088

COUNT BOX 10U.  
ÉTUIS CHILD RESISTANT



REGARDEZ LA VIDEO

Consultez les pages 272-276 pour une explication détaillée des icônes.

BIC  
GRAPHIC

INSTRUMENTS  
D'ÉCRITURE BIC®

AUTRES INSTRUMENTS  
D'ÉCRITURE

CARNETS

BRIQUETS BIC® / DJEEP®  
ET ÉTUIS BIC®

EMBALLAGES  
BIC®

INFORMATIONS  
GÉNÉRALES

# BIC® J38 BRIQUET

---

2452



*l'iconique BIC® Boy et  
le logo BIC® gravé !*

**BIC® J38 BRIQUET**  
2452



57



25



02



03



*Allumage  
confortable !*

échelle 1:1

# BIC® J38 BRIQUET

2452

## BIC® J38 BRIQUET

2452

A/C SP: max. 4 coul.

Commande minimale 300 u.

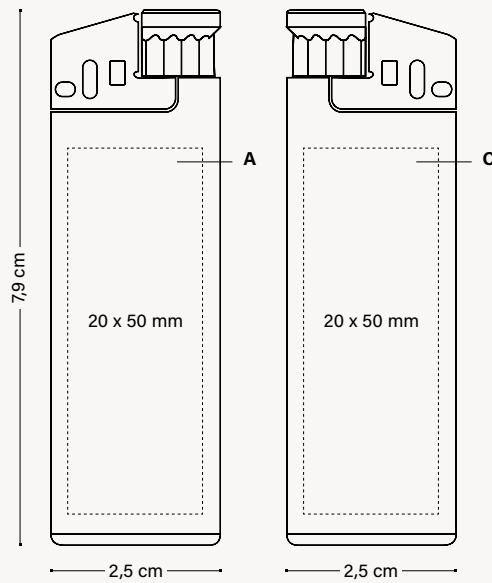

### EMBALLAGE



100% recyclé !

EMBALLAGE STANDARD :  
BARQUETTE DE 50 UNITÉS

### EMBALLAGE EXTERNE



600 ± 13,2 KG



FSC ET CARTON  
RECYCLABLE

### EMBALLAGE INTÉRIEUR OPTIONNEL

0087

COUNT BOX 10U. ÉTUIS



0088

COUNT BOX 10U.  
ÉTUIS CHILD RESISTANT



FABRIQUÉ ET  
IMPRIMÉ DANS  
LES USINES BIC



FABRIQUÉ  
EN ESPAGNE



RESPECTANT  
LES NORMES



JUSQU'À 1.800



TECHNIQUES  
D'IMPRESSION



SÉRIGRAPHIE

DURABILITÉ



IMPRIM'VERT®



100 % DE L'ÉLECTRICITÉ  
PROVIENT DE SOURCES  
RENOUVELABLES



REGARDEZ LA VIDEO

Consultez les pages 272-276 pour une explication détaillée des icônes.

FINITIONS NUMÉRIQUES



**BR** BRILLIANT



**MT** MATT

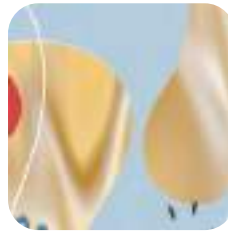

**H** HOLOGRAPHIC SILVER GOLD



**P** PUFFY



**M** METALLIC



**UV** UV



**PG** PUFFY GLITTER

2452

BIC® J38 BRIQUET  
2452



57

**BR** BRILLIANT



57

**MT** MATT



impression  
360°

échelle 1:1

57

**MT** MATT

**H** HOLOGRAPHIC GOLD

# BIC® J38 BRIQUET

2452

**BIC® J38 BRIQUET**

2452

**A DG:** Numérique

Commande minimale 600 u.

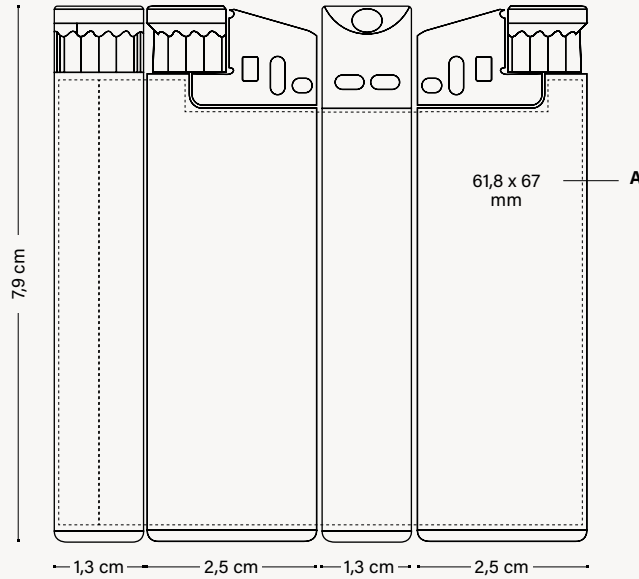

TECHNIQUES D'IMPRESSION



DURABILITÉ



## EMBALLAGE



100% recyclé !

EMBALLAGE STANDARD :  
BARQUETTE DE 50 UNITÉS

## EMBALLAGE EXTERNE



600 ± 13,2 KG



FSC ET CARTON  
RECYCLABLE

## EMBALLAGE INTÉRIEUR OPTIONNEL

0087

COUNT BOX 10U. ÉTUIS



0088

COUNT BOX 10U.  
ÉTUIS CHILD RESISTANT



REGARDEZ LA VIDEO

Consultez les pages 272-276 pour une explication détaillée des icônes.

BIC  
GRAPHIC

INSTRUMENTS  
D'ÉCRITURE BIC®

AUTRES INSTRUMENTS  
D'ÉCRITURE

CARNETS

BRIQUETS BIC® / DJEEP®  
ET ÉTUIS BIC®

EMBALLAGES  
BIC®

INFORMATIONS  
GÉNÉRALES

# FLAMME SÛRE

Les doigts restent éloignés de la flamme.



Longue durée de vie, jusqu'à 900 allumages

**Flamme stable**

grâce au gaz isobutane pur



**Format pratique**

Il se glisse facilement dans la poche



Fabriqué en Espagne



Pratique pour différentes situations requérant une flamme



Sûr et fiable



**Maintient les doigts éloignés de la flamme**

grâce à sa tige de 3,5 cm

Système d'allumage très puissant



Produit avec 100 % électricité d'énergie renouvelable

**Grande résistance**

Fabriqué en résine à forte résistance mécanique Delrin®

# BIC® EZ REACH™ BRIQUET

2450



**BIC® EZ REACH™ BRIQUET**

2450

**A SP:** max. 1 coul.

**B BP:** Numérique

Commande minimale 300 u.



01

02

03



12

25

04

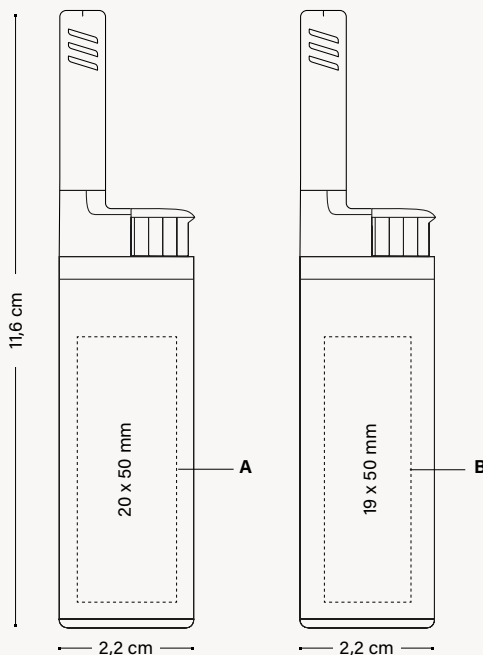

## EMBALLAGE



EMBALLAGE STANDARD :  
BARQUETTE DE 50 UNITÉS.

## EMBALLAGE EXTERNE



150 ± 3.8 KG



FSC ET CARTON  
RECYCLABLE



MADE IN  
SPAIN



RESPECTANT  
LES NORMES



JUSQU'À 900



MAINTIENT LES DOIGTS  
ÉLOIGNÉS DE LA FLAMME



IL SE GLISSE FACILEMENT  
DANS LA POCHE

## TECHNIQUES D'IMPRESSION



SÉRIGRAPHIE



BRITEPIX™

## DURABILITÉ



100 % DE L'ÉLECTRICITÉ  
PROVIENT DE SOURCES  
RENOUVELABLES

BIC  
GRAPHIC

INSTRUMENTS  
D'ÉCRITURE BIC®

AUTRES INSTRUMENTS  
D'ÉCRITURE

CARNETS

BRIQUETS BIC® / DJEEP®  
ET ÉTUIS BIC®

EMBALLAGES  
BIC®

INFORMATIONS  
GÉNÉRALES

Consultez les pages 272, 276 pour une explication détaillée des icônes.

Décorez votre briquet  
avec des étuis uniques et  
personnalisables !

Protégez-le, et démarquez-vous  
avec originalité.

Personnalisez-le



**2386**  
BIC® Styl'it Luxury Étui



**2156**  
BIC® Aluminium Flat Étui



**2398**  
BIC® Clip Étui



**2395**  
BIC® 3D Étui



**3850**  
BIC® Cendrier de Poche



**3851**  
BIC® Cendrier de Poche Kraft

BIC  
GRAPHIC

INSTRUMENTS  
D'ÉCRITURE BIC®

AUTRES INSTRUMENTS  
D'ÉCRITURE

CARNETS

BRIQUETS BIC® / DJEEP®  
ET ÉTUIS BIC®

EMBALLAGES  
BIC®

INFORMATIONS  
GÉNÉRALES

2386

**BIC® STYL'IT LUXURY ÉTUI**  
2386



*Tous les étuis sont livrés avec un briquet blanc BIC® J25 !*



59

01

échelle 1:1

2386

**BIC® STYL'IT LUXURY ÉTUI**  
2386

Commande minimale 100 u.  
**A/C LE**

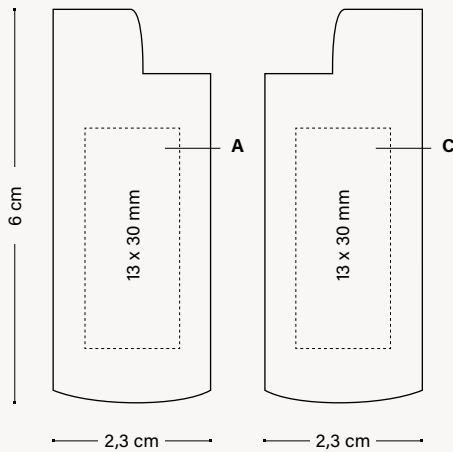

Commande minimale 100 u.  
**A/C PD**

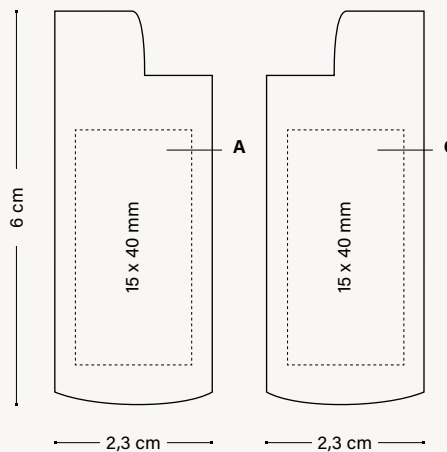

## EMBALLAGE

0087

COUNT BOX 10 UNITÉS ÉTUIS



## EMBALLAGE INTÉRIEUR OPTIONNEL

4551

BOX DE 50 UNITÉS STYL'IT ÉTUIS



## EMBALLAGE EXTERNE



300 ± 6,1 KG



FSC ET CARTON  
RECYCLABLE



IMPRIMÉ DANS  
LES USINES BIC



RESPECTANT  
LES NORMES



TECHNIQUES  
D'IMPRESSION



TAMPOGRAPHIE



LASER

DURABILITÉ



BIC  
GRAPHIC

INSTRUMENTS  
D'ÉCRITURE BIC®

AUTRES INSTRUMENTS  
D'ÉCRITURE

CARNETS

BRIQUETS BIC® / DJEEP®  
ET ÉTUIS BIC®

EMBALLAGES  
BIC®

INFORMATIONS  
GÉNÉRALES

# BIC® ALUMINIUM FLAT ÉTUI

2156

**BIC® ALUMINIUM FLAT ÉTUI**  
2156

3 faces  
personnalisables !



Tous les étuis sont  
livrés avec un briquet  
blanc BIC® J25 !



échelle 1:1

47

2156

**BIC® ALUMINIUM FLAT ÉTUI**  
2156

Commande minimale  
100 u.  
A/C PD: max. 1 coul.

Commande minimale  
100 u.  
A/B/C BP: Numérique

Commande minimale  
100 u.  
A/B/C LE

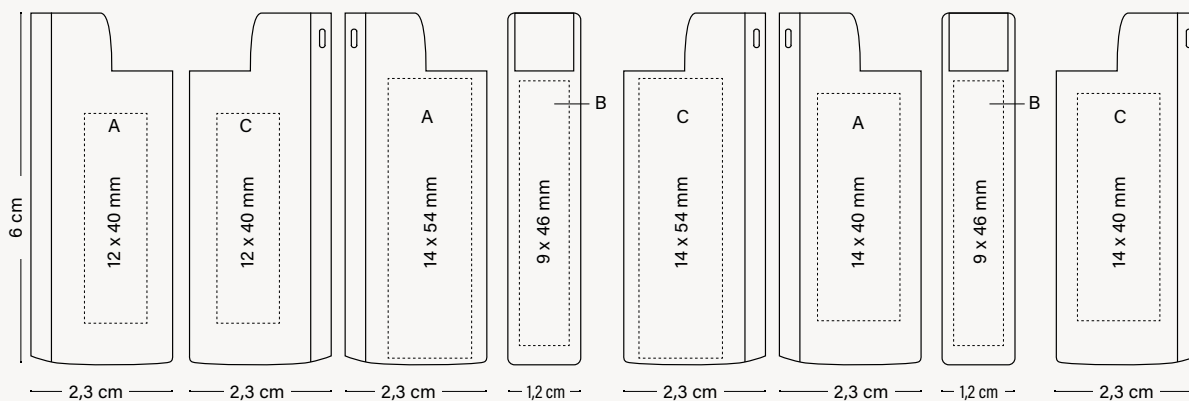

## EMBALLAGE

4551

BOX DE 50 UNITÉS



## EMBALLAGE EXTERNE



300 ± 7,5 KG



FSC ET CARTON  
RECYCLABLE



IMPRIMÉ DANS  
LES USINES BIC

Conform  
ISO 9994



RESPECTANT  
LES NORMES

Conform  
EN 13869 85%

## TECHNIQUES D'IMPRESSION

PD TAMPOGRAPHIE

BP BRITEPIX™  
BRITEPIX™ PERSONNALISATION

LE LASER

## DURABILITÉ

IMPRIM'VERT®

# BIC® CLIP ÉTUI

2398

**BIC® CLIP ÉTUI**  
2398



Tous les étuis sont livrés avec un briquet blanc BIC® J25 !



03

02

échelle 1:1

2398

**BIC® CLIP ÉTUI**  
2398

Commande minimale  
100 u.  
A/C PD: max. 1 coul.

Commande minimale  
100 u.  
A/C BP: Numérique  
BP Texture: Numérique

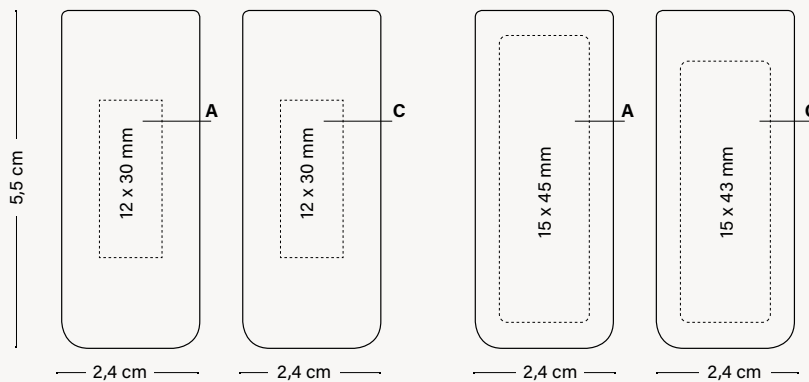

## EMBALLAGE

4551

BOÎTE DE 50 UNITÉS



## EMBALLAGE EXTERNE



300 ± 7,5 KG



FSC ET CARTON  
RECYCLABLE



## TECHNIQUES D'IMPRESSION

PD TAMPOGRAPHIE

BP BRITEPIX™  
BRITEPIX™ PERSONALISATION

## DURABILITÉ



Consultez les pages 272-276 pour une explication détaillée des icônes.

2395

**BIC® 3D ÉTUI**  
2395



*Tous les étuis sont livrés  
avec un briquet blanc  
BIC® J25 !*



*Convertissez  
votre logo en  
3D !*

échelle 1:1

# BIC® 3D ÉTUI

2395

## BIC® 3D ÉTUI

2395

A/C 3D: max. 6 coul.

Commande minimale 1.200 u.

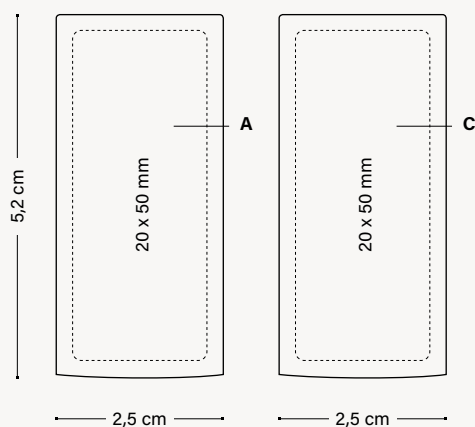

RESPECTANT  
LES NORMES



TECHNIQUES  
D'IMPRESSION



3D  
EMBOSSING

### EMBALLAGE

4551

BOX DE 50 UNITÉS



### EMBALLAGE EXTERNE



300 ± 7,5 KG



FSC ET CARTON  
RECYCLABLE

Consultez les pages 272-276 pour une explication détaillée des icônes.

# BIC® CENDRIER DE POCHE

3850

**BIC® CENDRIER DE POCHE**  
3850

6 formes  
à rabat  
disponibles



Réutilisable  
et hermétique



échelle 1:1

3850

**BIC® CENDRIER DE POCHE**  
3850

**A SP:** max. 5 col. (2 couleurs max.  
pour les commandes inférieures à  
20.000 u.)

Commande minimale 5.000 u.

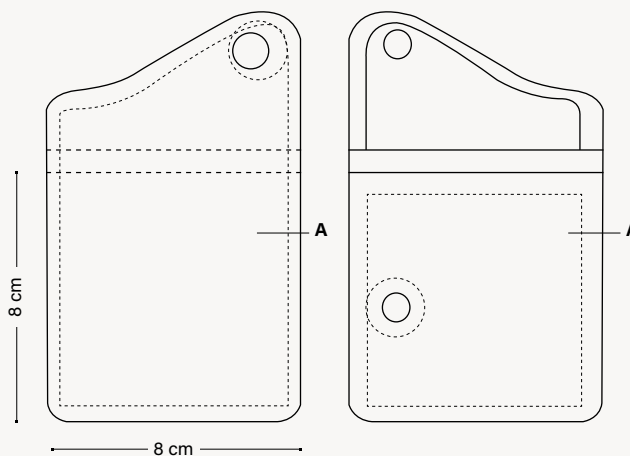

## EMBALLAGE



BOÎTE DE 10 UNITÉS.  
CHAQUE CENDRIER DE  
POCHE BIC® EST MIS SOUS  
EMBALLAGE INDIVIDUEL  
(CELLOPHANE).

## EMBALLAGE EXTERNE



500 ± 5,5 KG



RESPECTANT  
LES NORMES

## TECHNIQUES D'IMPRESSION



SÉRIGRAPHIE

Pour de plus amples détails, veuillez contacter notre service clients.

# BIC® CENDRIER DE POCHE

3851

**BIC® CENDRIER DE POCHE**  
3851 Kraft



échelle 1:1

6F

3851

**BIC® CENDRIER DE POCHE KRAFT**

3851 Kraft

A SP: max. 2 col.

Commande minimale 10.000 u.

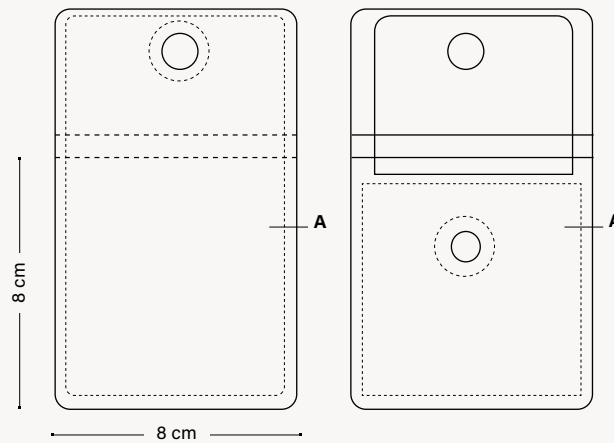

## EMBALLAGE



BOÎTE DE 10 UNITÉS.  
CHAQUE CENDRIER DE  
POCHE BIC® EST MIS SOUS  
EMBALLAGE INDIVIDUEL  
(CELLOPHANE).

## EMBALLAGE EXTERNE



500 ± 5,5 KG



RESPECTANT  
LES NORMES

## TECHNIQUES D'IMPRESSION

**SP** SÉRIGRAPHIE

Consultez les pages 272, 276 pour une explication détaillée des icônes.

Pour de plus amples détails, veuillez contacter notre service clients.

Durable et conçu avec style. Le briquet DJEEP® est créé pour fonctionner parfaitement. Chaque briquet est entièrement testé pour s'assurer qu'il répond à nos critères de qualité les plus stricts.



**08D1**  
DJEEP® D1 Briquet



**08D1**  
DJEEP® D1 Briquet



**08D1**  
DJEEP® D1 Briquet



**08D1**  
DJEEP® D1 Briquet

Allumez votre étincelle

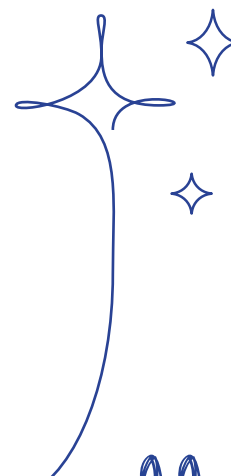



**Ignite your  
mark.**

We are  
**premium**

We are  
**singular**



We are  
**engaged**

We are  
**creative**

# DJEEP® D1 BRIQUET

Durable et conçu avec style. Le briquet DJEEP® est créé pour fonctionner parfaitement. Chaque briquet est entièrement testé pour s'assurer qu'il répond à nos critères de qualité les plus stricts.

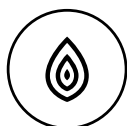

**FLAMME STABLE**  
grâce au gaz isobutane pur



**UN BRIQUET CONÇU POUR DURER**  
grâce à sa technologie à trois réservoirs



**RÉSERVOIR TRÈS RÉSISTANT**  
en résine à forte résistance mécanique



**GRAND POUSSOIR**  
pour un meilleur confort d'utilisation



**EFFETS HAUT DE GAMME**

Qualité de fabrication conforme aux normes de sécurité internationales. Fabriqué en France



**FORME RECTANGULAIRE UNIQUE**  
pour une bonne tenue en main et une grande surface d'expression

**SÉCURITÉ ENFANTS**  
conforme à la norme EN 13869

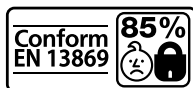

# Décoration numérique 360°

DJEEP® propose une grande variété d'effets d'impression numérique. Pour doter chaque briquet d'une personnalité, vous avez le choix entre touch & feel, glossy & matt mix, etched, Holographik®...



## 01. Base. Choisissez entre :

WM WHITE MEDIUM     M METALLIC SILVER     H HOLOGRAPHIC

**02. Impression :** Nous choisissons la meilleure option pour vous (numérique, offset, flexographie, sérigraphie) en fonction des quantités et des options de design.

## 03. Finition. Choisissez entre :

G GLOSSY     MT MATT     ST DJEEP SOFT TOUCH®

**04. Options de décoration.** Choisissez jusqu'à 2 options de décoration différentes entre : GRANITE, FABRIC, DJEEP® SOFT TOUCH®, RESIN CHIP, TOUCH&FEEL, GLOSSY & MATT MIX, BLACK LIGHT, HAMMERED METAL, GLITTERING, FRAGRANT INK, GLOW IN THE DARK, ETCHED, QR CODE, HOLOGRAPHIK®, PEARLESCENT.

## POSSIBILITÉS DE DÉCORATION



ST

### DJEEP® SOFT TOUCH®

Offrez une sensation de douceur unique ! Des tons profonds et une surface douce pour vivre une expérience exclusive.



GT

### GLITTERING

Ajoutez un effet scintillant à votre design ! Rendez vos couleurs vibrantes !



HM

### HAMMERED METAL

Un fond métallisé avec un motif effet en relief. Un look et une sensation vraiment premium pour se démarquer !



TF

## TOUCH & FEEL

Donnez un effet gaufré à votre design !



ET

## ETCHED

Donnez un effet gravé au briquet !  
Créez des motifs et convertissez votre idée en un design élégant.



GM

## GLOSSY & MATT MIX

Choisissez cette finition pour créer des distinctions entre le mat ou DJEEP® Soft Touch® et le vernis UV qui donne de la vivacité aux couleurs.



FI

## FRAGRANT INK

Collez l'étiquette et profitez du parfum !  
Parfums disponibles : Menthe, Fruits rouges, Mojito, Citron vert et Ananas.



OR

## QR CODE

Redirigez votre client vers un site Web, un numéro de téléphone ou un message. Créez de l'interactivité entre le briquet et votre message !



BL

## BLACK LIGHT

Sous la lumière noire, les couleurs fluorées apparaissent. Vous pouvez avoir des couleurs bleu clair, rouge, vert et jaune.



FA

## FABRIC

Donnez l'aspect et le toucher d'une texture de tissu avec du relief et une finition mate !



RC

## RESIN CHIP

Ajoutez du volume à votre design !  
Donnez au briquet une troisième dimension !



GR

## GRANITE

Ajoutez une sensation granuleuse au briquet !



GD

## GLOW IN THE DARK

Exposez le briquet DJEEP® sous une ampoule ou directement au soleil et observez la poudre photoluminescente sur les endroits sombres ! Faites briller votre design dans le noir !



H

## HOLOGRAPHIK®

Une surface argentée réfléchissante pour montrer la haute qualité et l'innovation !



PE

## PEARLESCENT

Brillant nacré et subtil qui transmet de l'élégance et de la délicatesse !

# DJEEP® BRIQUETS

08D1

**DJEEP® D1 BRIQUET**  
08D1

Commande minimale 10.000 u.  
Combinaison de couleurs standards



**MIX &  
MATCH**

Sans frais supplémentaires

## Capot

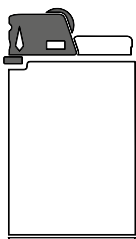

## Poussoir

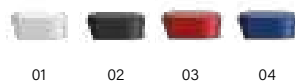
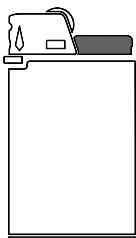

## Réservoir

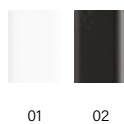
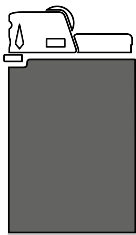

08D1

## DJEEP® D1 BRIQUET

08D1

A DG: Numérique

Commande minimale 10000 u.

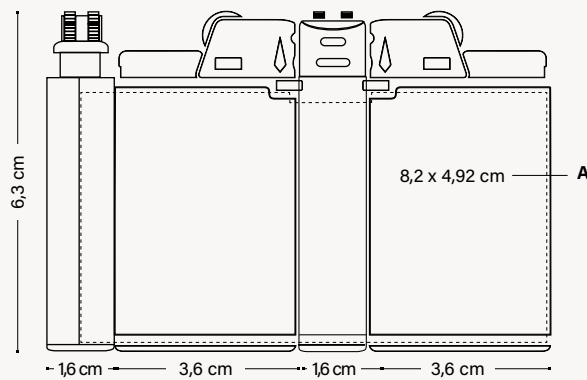

### EMBALLAGE



EMBALLAGE STANDARD:  
BOÎTE DE 10 U.

Carton recyclable

### EMBALLAGE EXTERNE



600 ± 20 KG



FSC ET CARTON  
RECYCLABLE

MIX &  
MATCH



FABRIQUÉ ET  
IMPRIMÉ DANS  
LES USINES DJEEP

FABRIQUÉ  
EN FRANCE



RESPECTANT  
LES NORMES



JUSQU'À 3.500

Conform  
ISO 9994



Conform  
EN 13869 85%

TECHNIQUES  
D'IMPRESSION



DIGITAL

DURABILITÉ



100 % DE L'ÉLECTRICITÉ  
PROVIENT DE SOURCES  
RENOUVELABLES



REGARDEZ LA VIDEO



# EMBALLAGES

# BIC®

---

# 05

---

Boîtes-cadeaux, pochettes et étuis pour l'emballage personnalisé des stylos, qui mettent en valeur chaque cadeau d'écriture. Packs personnalisables disponibles pour s'adapter à votre style.



## FAMILLE EMBALLAGE PRIMAIRE BIC®

### Emballage Primaire BIC® Ecolutions®

**ecolutions®**

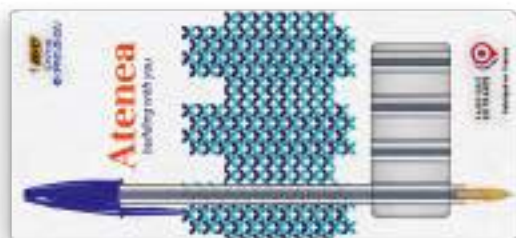

**3469015464**

BIC® Collection Box Slim Pens  
4 unités



**3469013355** (Pour 1 unité)

**3469013356** (Pour 2 unités)

**3469013357** (Pour 3 unités)

BIC® Collection Box



**3469007684**

BIC® Eco Sleeve



**3469007685**

BIC® Window Box



**3469007686**

BIC® Plastic Pouch



**3469007687**

BIC® Marking Set

### Emballage Primaire BIC®



**34672000039**

BIC® Black Velvet Pouch 1 unité



**3467000041**

BIC® Frosted Pouch (Pour 1 ou 2 unités)



**34670000042** (Pour 1 unité)

**34670000043** (Pour 2 unités)

**34670000044** (Pour 3 unités)

**3469001173** (Pour 4 unités)

BIC® Cello Wrap

3469015464

**BIC® COLLECTION BOX SLIM PENS 4 UNITÉS**

Emballage en carton FSC. Personnalisable sur chaque face offrant de belles surfaces de communication. Idéal pour proposer nos produits iconiques BIC® à travers une collection. Plus qu'un stylo, un excellent moyen d'optimiser vos ventes.



FSC ET CARTON RECYCLABLE

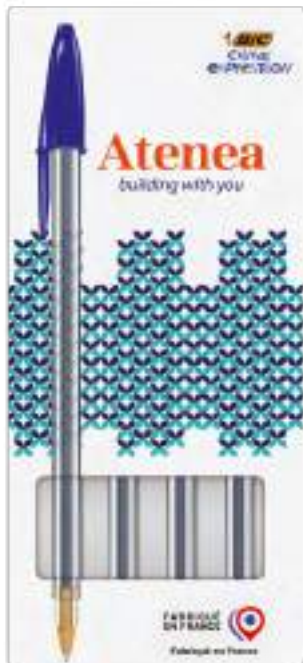

Emballage spécial pour:



- BIC® CRISTAL® EXPRESSION
- BIC® ROUND STIC®
- BIC® STYLE
- BIC® CLIC STIC
- BIC® CRISTAL® RE'NEW™

100% personnalisable à partir de 100 unités !

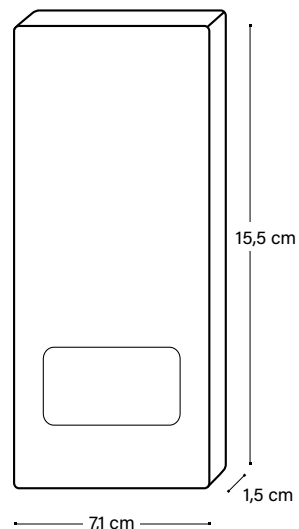

3469013355 / 3469013356 / 3469013357

**BIC® COLLECTION BOX**

Emballage en carton FSC. Personnalisable sur chaque face offrant de belles surfaces de communication. Idéal pour proposer nos produits iconiques BIC® à travers une collection. Plus qu'un stylo, un excellent moyen d'optimiser vos ventes.

- 3469013355 - 1 unité
- 3469013356 - 2 unités
- 3469013357 - 3 unités

100% personnalisable à partir de 100 unités !



FSC AND RECYCLABLE CARDBOARD

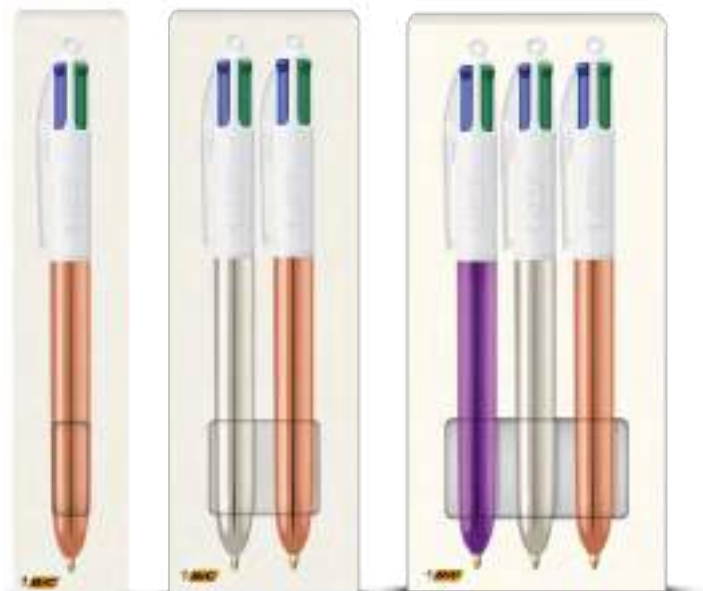

Emballage spécial pour:



- BIC® 4 COULEURS®
- BIC® WIDE BODY™
- BIC® SUPER CLIP
- BIC® BRITE LINER® GRIP
- BIC® GRIP ROLLER

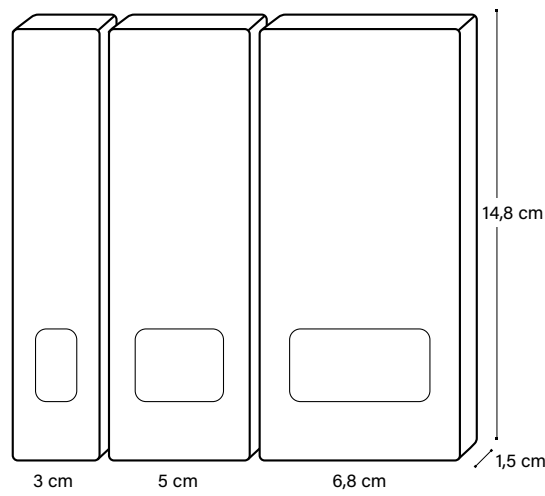

3469007684

**BIC® ECO SLEEVE**

Pochette spéciale recyclée pour tous les instruments d'écriture BIC® à l'exception des crayons à papier.



FSC ET CARTON RECYCLABLE



CARTON RECYCLÉ



Emballage spécial pour:



- BIC® MEDIA CLIC
- BIC® CLIC STIC
- BIC® SUPER CLIP
- BIC® WIDE BODY™
- BIC® INTENSITY® GEL CLIC

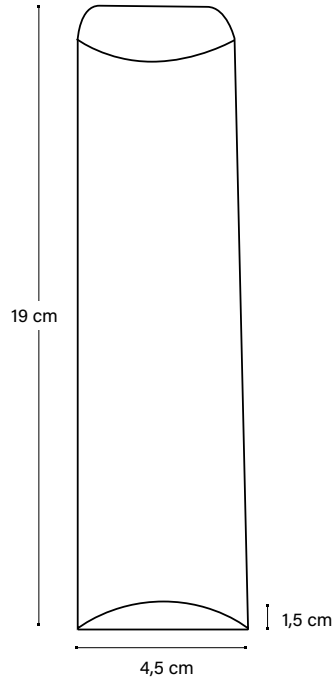

FABRIQUÉ EN ESPAGNE



RESPECTANT LES NORMES

DURABILITÉ



3469007685

**BIC® WINDOW BOX**

Emballage design haut de gamme pour tous les instruments d'écriture BIC® à l'exception des crayons à papier.



FSC ET CARTON RECYCLABLE

Emballage spécial pour:



BIC® METALLIC PENS



Remarque : les stylos présentés sont uniquement destinés à des fins d'illustration et ne sont pas inclus dans le prix.

BIC GRAPHIC

INSTRUMENTS D'ÉCRITURE BIC®

AUTRES INSTRUMENTS D'ÉCRITURE

CARNETS

BRIQUETS BIC® / DJEEP® ET ÉTUIS BIC®

EMBALLAGES BIC®

INFORMATIONS GÉNÉRALES

Consultez les pages 272-276 pour une explication détaillée des icônes.

3469007686

**BIC® PLASTIC POUCH**

Design spécial pour cet emballage qui s'adapte à tous les instruments d'écriture et pour 3 crayons à papier.



FSC ET CARTON RECYCLABLE



PLASTIQUE RECYCLABLE

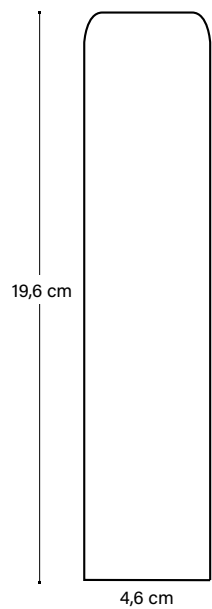

3469007687

**BIC® MARKING SET**

Emballage conçu pour tous les types de marqueurs.



FSC ET CARTON RECYCLABLE



RECYCLABLE PLASTIC



Emballage spécial pour:



**3 BIC® BRITE LINER® GRIP**  
**3 BIC® MARK-IT**



**3 BIC® VELLEDA® GRIP**  
**3 BIC® VELLEDA® FINE**



34670000042 / 34670000043 / 34670000044 / 3469001173

**BIC® CELLO WRAP**

Emballage enveloppe en matière plastique résistante et transparente.

- 34670000042 - 1 unité
- 34670000043 - 2 unités
- 34670000044 - 3 unités
- 3469001173 - 4 unités



Cello wrap 1 unité



Cello wrap 2 unités

# EMBALLAGE PRIMAIRE BIC®

3467000041

## BIC® FROSTED POUCH (POUR 1 OU 2 ARTICLES)

Emballage transparent pour 2 instruments d'écriture.

A SP: max. 1 coul.

Emballage spécial pour:



BIC® 4 COULEURS®  
BIC® MEDIA CLIC  
BIC® ROUND STIC®  
BIC® CLIC STIC  
BIC® WIDE BODY™  
BIC® SUPER CLIP  
BIC® M10® CLIC  
BIC® STYLE  
BIC® METAL PRO  
BIC® EVOLUTION® ECOLUTIONS® CRAYON AVEC GOMME  
BIC® EVOLUTION® ECOLUTIONS® CRAYON SANS GOMME  
BIC® MATIC®  
BIC® INTENSITY®  
BIC® GRIP ROLLER  
BIC® VELLEDA®  
BIC® PERMANENT MARKER ECOLUTIONS®  
BIC® MARK-IT PERMANENT MARKER  
BIC® BRITE LINER® GRIP  
BASIC PEN  
STRIPED GRIP PEN  
SLEEK STYLUS PEN  
CLICK PEN



1:2 scale

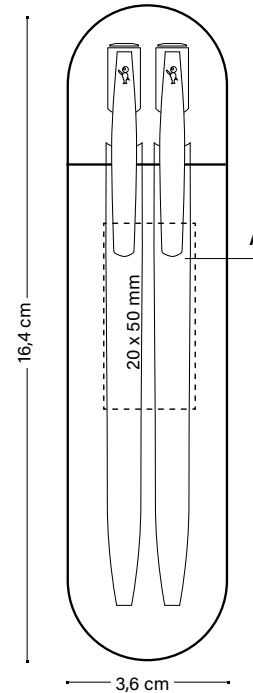

34672000039

## BIC® BLACK VELVET POUCH 1 ARTICLE

Emballage exclusif en velours pour 1 instrument d'écriture.  
Spécialement recommandé pour les stylos métal.



1:2 scale

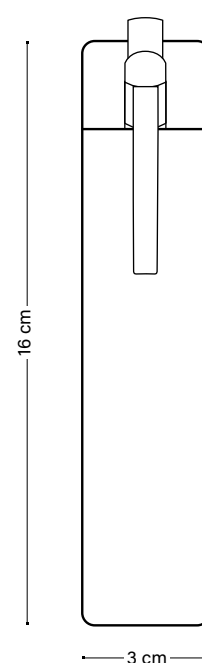

Remarque : les stylos présentés sont uniquement destinés à des fins d'illustration et ne sont pas inclus dans le prix.

Solutions pratiques et faciles à manipuler, simplifiant le stockage, la manutention et le transport, pour rendre les opérations quotidiennes plus fluides et efficaces pour chaque client.

Emballage Secondaire BIC®



**3467000009**  
**3467000008**  
**3467000007**  
Count Box



**3467000013**  
**3467000011**  
**3467000010**  
Plastic Bag

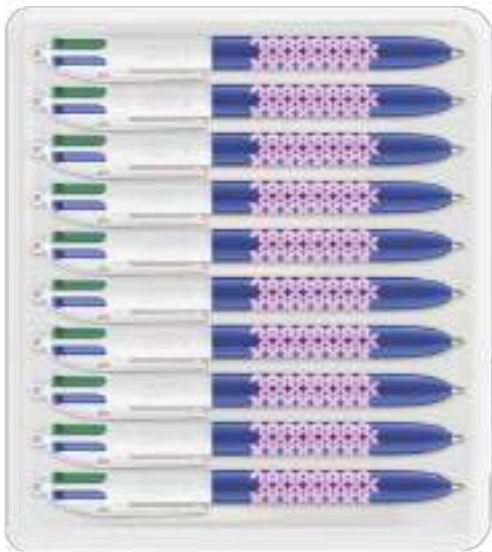

**34670000080**  
Tray of 10 Writing Instruments

Consultez les pages 272-276 pour une explication détaillée des icônes.

## EMBALLAGE SECONDAIRE BIC®

---

3467000009 / 3467000008 / 3467000007

---

### COUNT BOX

3467000009 - **Petit** (pour 25 BIC® Clic Stic) - 6 x 6,2 x 14 cm

3467000008 - **Moyen** (pour 50 BIC® Media Clic ou Stylo BIC® de mêmes dimensions) - 7,5 x 7,5 x 15,2 cm

3467000007 - **Grand** (uniquement pour 100 BIC® Evolution® Ecolutions®) - 7,5 x 7,5 x 19 cm

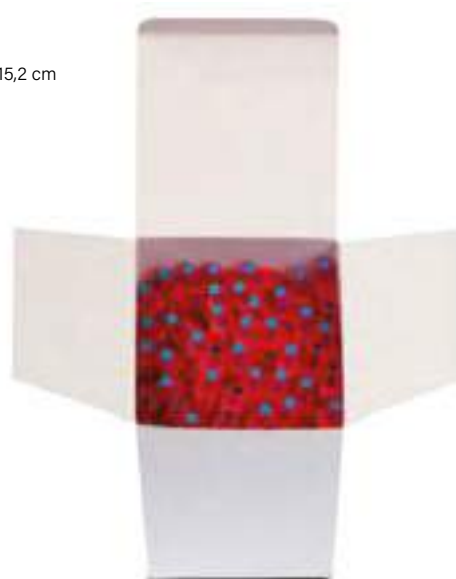

3467000013 / 3467000011 / 3467000010

---

### PLASTIC BAG

3467000013 - **Petit** (pour 25 BIC® Media clic ou Stylo BIC® de mêmes dimensions) 12 x 18 cm

3467000011 - **Moyen** (pour 50 BIC® Media clic ou Stylo BIC® de mêmes dimensions) 15 x 22 cm

3467000010 - **Grand** (pour 100 BIC® Media clic ou Stylo BIC® de mêmes dimensions) 20 x 30 cm



3467000080

TRAY OF 10 WRITING  
INSTRUMENTS

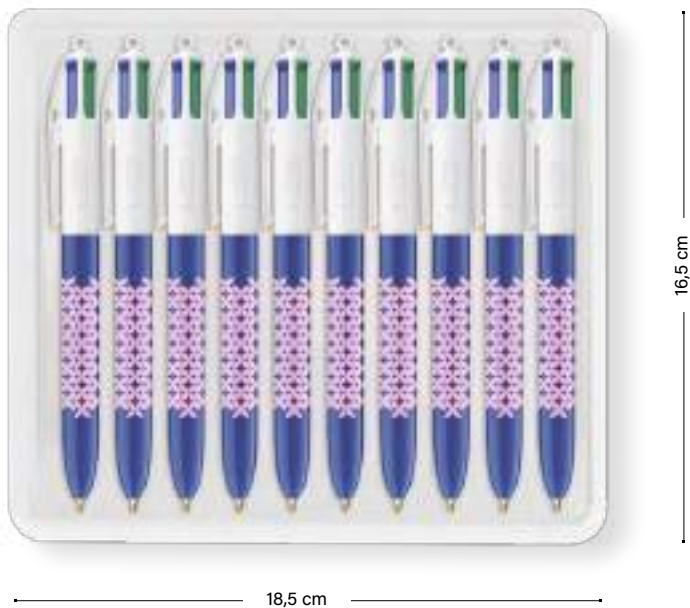

Please note: Pens shown are for display purposes only and are not included in the price.



# INFORMATIONS GÉNÉRALES

---

# Aperçu du Catalogue

Cette section fournit des informations de référence essentielles pour naviguer efficacement dans le catalogue. Elle offre un cadre clair et structuré qui facilite l'identification, la comparaison et la sélection des produits, garantissant une expérience de lecture cohérente et simple.

Commandez en toute simplicité !

Symboles et abréviations

Index des produits

Nuancier de Couleurs

## INFORMATIONS CONCERNANT LES FICHIERS

Veillez charger votre fichier sous l'un des formats suivants:

- Un fichier électronique avec le dessin graphique
- Et un fichier différent pour le texte. Pour un marquage au laser individuel, les textes devront être fournis uniquement sous format Excel® (.xls)

## PROPRIÉTÉS DU MATÉRIEL GRAPHIQUE

Envoyez-nous votre matériel graphique dans un des types de fichiers suivants :

- JPG / 350 dpi non comprimé à la taille réelle de marquage (seulement images, sans texte)
- PDF / vectorisé
- Illustrator® CC / vectorisé
- Photoshop® CC / avec les calques
- Fichiers ZIP
- Il est important que vous nous fassiez parvenir les informations dans l'un de ces formats afin de traiter au mieux votre commande et d'obtenir un résultat final optimal. Si la création du client ne rentre pas dans notre format, nous la modifierons en conséquence.

## TYPE DE CARACTÈRES :

Tous les types de caractères doivent être convertis en image. Vérifiez les tailles minimales des types et les épaisseurs de trait. Veuillez contacter le service clientèle pour plus d'informations.

COMMANDEZ EN TOUTE SIMPLICITÉ !

## SPÉCIAL POUR LES INSTRUMENTS D'ÉCRITURE

SÉRIGRAPHIE



La zone d'impression disponible dépend de la technique d'impression requise.

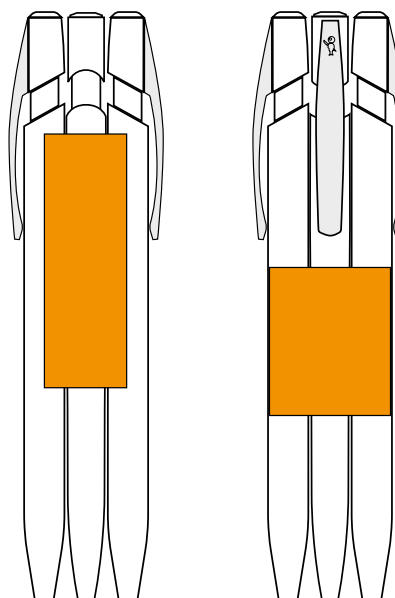

Clip arrière

Clip centré

## SPÉCIAL POUR LES BRIQUETS (J25, J23, J26 ET J38)

Pour toute demande de couleur directe Pantone, nous pouvons proposer une impression avec une 5ème couleur disponible dans ce catalogue, à un prix majoré. Pour plus d'informations sur la manière d'obtenir la couleur correspondante la plus proche pour des impressions sur différents produits de notre catalogue, veuillez contacter notre service client.

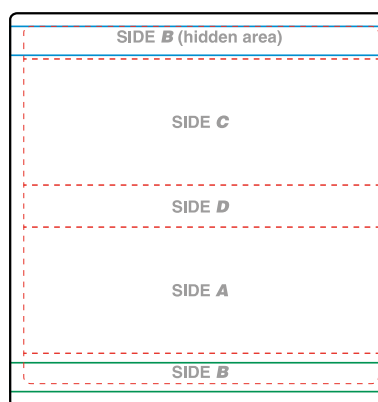

BIC  
GRAPHIC

INSTRUMENTS  
D'ÉCRITURE BIC®

AUTRES INSTRUMENTS  
D'ÉCRITURE

CARNETS









































BRIQUETS BIC®/DJEEP®  
ET ÉTUIS BIC®

EMBALLAGES  
BIC®

INFORMATIONS  
GÉNÉRALES

# SYMBOLES ET ABRÉVIATIONS

## Symboles des techniques d'impression

	<b>Puffy glitter</b> Texture avec paillettes colorées.		<b>britePix™</b>		<b>Laser</b>
	<b>Puffy</b> Une personnalisation soulignée par notre encre « Puffy », pour donner un effet de relief à votre logo.		<b>3D embossage</b>		<b>Metallic Foil</b>
	<b>Brilliant</b> Finition brillante.		<b>Debossing</b>		<b>Pad printing</b>
	<b>Metallic</b> Crée des effets métalliques sur les images ou l'arrière-plan.		<b>Touch &amp; feel</b>		<b>Touch &amp; feel</b>
	<b>Holografic</b> Crée des effets attractifs en or ou argent.		<b>Etched</b>		<b>Sérigraphie</b>
	<b>Matt</b> Finition mate.		<b>Glossy &amp; matt mix</b>		<b>Gravure laser</b>
	<b>UV</b> Finition extra brillante.		<b>Fragrant ink</b>		<b>Tampographie</b>
	<b>Hot Stamping</b> Graver en relief sensible au toucher.		<b>QR code</b>		<b>Quadrichromie</b>
	<b>Impression 360° degrés</b>		<b>Black light</b>		<b>Glow in the dark</b>
	<b>Impression 360° degrés</b>		<b>Fabric</b>		<b>Holographik®</b>
	<b>Digital</b> Quadrichromie haute définition. À 360° degrés et sur toute la longueur du corps.		<b>Resin chip</b>		<b>Pearlescent</b>
	<b>britePix™ Digital</b> La solution pour une communication tout en couleur. Maintenant sur des corps en couleur.		<b>Granite</b>		<b>Djeep® soft touch®</b>
	<b>britePix™ Texture</b> britePix™ Texture apporte une nouvelle touche haut de gamme au concept britePix™. Désormais, vous pouvez non seulement voir tout en couleur, mais aussi le toucher !		<b>Glittering</b>		<b>Hammered metal</b>
	<b>britePix™ personalisation</b> Personnalisez chaque unité dans une seule et même commande.				

# SYMBOLES ET ABRÉVIATIONS

## Modes d'écriture

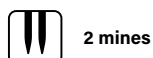
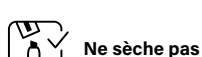
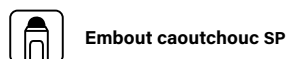
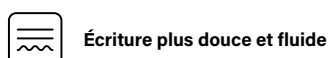
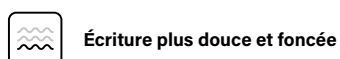
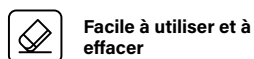

## Couleurs d'encre

- Noir
- Vert clair
- Bleu clair
- Vert pomme
- Bleu foncé
- Vert foncé
- Rouge
- Fluo
- Orange
- Rose
- Jaune
- Violet

BIC  
GRAPHIC

INSTRUMENTS  
D'ÉCRITURE BIC®

AUTRES INSTRUMENTS  
D'ÉCRITURE

CARNETS























BRIQUETS BIC®/DJEEP®  
ET ÉTUIS BIC®

EMBALLAGES  
BIC®

INFORMATIONS  
GÉNÉRALES

# SYMBOLES ET ABRÉVIATIONS

## Autres symboles

	<b>EN 13869</b> Règlement de sécurité des enfants pour les briquets		<b>Fabriqué en Europe</b>
	<b>Certification ISO</b>		<b>Fabriqué en France</b>
	<b>ISO</b> Normes internationales de sécurité		<b>Fabriqué en Espagne</b>
	<b>Nouveau</b>		<b>Réduction virale 93% en 24h</b>
	<b>Mix&amp;Match</b> Des centaines de couleurs de composants en stock pour la personnalisation complète des instruments d'écriture.		<b>Protection sur toute la surface du stylo</b>
	<b>Couleurs personnalisées</b> Choisissez la couleur exacte pour des décorations les mieux adaptées à votre logo.		<b>Protection à vie</b>
	<b>Fabriqué et imprimé dans les usines BIC</b>		<b>Protection antibactérienne</b>
	<b>Fabriqué dans les usines BIC</b>		<b>Inhibition des champignons en 24h</b>
	<b>Imprimé dans les usines BIC</b>		<b>Gardez les doigts loin de la flamme</b>
	<b>Montage et impression dans les usines DJEEP</b>		<b>Se glisse facilement dans la poche</b>
	<b>Montage et impression dans les usines BIC</b>		<b>Nombre d'allumages</b>
	<b>Qualité et sécurité approuvées</b>		

## Autres symboles

ecolutions®



### FSC et carton recyclable

Produit fabriqué avec des matériaux respectant l'environnement, utilisant des matériaux renouvelables de conifères (polymères cellulosiques).



### Imprim'vert

Certification pour des pratiques d'impression respectueuses de l'environnement.



### Déchets pharmaceutiques



### Möbius Loop

Le produit contient des matériaux recyclés.



### Cageots de fruits et légumes



### Service de recharge



### Réfrigérateurs et pots de yaourt



### Code QR

Scannez le code QR



### Sucre de canne



### Informations sur l'emballage

250 ± 3,5 KG

**DIMENSIONS :** Les dimensions publiées de tous les produits correspondent à la taille maximale, quelle que soit la position du dessin.



### Pièces automobiles en plastique



### Respectant les normes



**100% Électricité d' énergie renouvelable**  
L'usine BIC Graphic Europe s'alimente 100% d'électricité renouvelable.

# PARAMÈTRES TECHNIQUES POUR CHACUN DES TYPES D'IMPRESSION

	NUMÉRIQUE / TRANSFERT DIGITAL	
Texte positif minimum	4 pt (1.4 mm)	4 Point text
Texte négatif minimum	7 pt (2.4 mm)	7 Point text
Texte minimum pour les demi-tons	1.5 pt (0.5 mm)	7 Point text
Épaisseur minimale des lignes positives	0.25 pt (0.08 mm)	—————
Épaisseur minimale des lignes négatives	0.5 pt (0.17 mm)	—————
Épaisseur minimale des demi-teintes	0.5 pt (0.17 mm)	—————
Valeurs minimales des demi-teintes	C: 8% / M: 8% / Y: 12% / K: 8% 	

	britePix™	
Texte positif minimum	6 pt (2.1 mm)	6 Point text
Texte négatif minimum	7 pt (2.4 mm)	7 Point text
Épaisseur minimale des lignes positives	0.4 pt (0.14 mm)	—————
Épaisseur minimale des lignes négatives	0.5 pt (0.17 mm)	—————
Épaisseur minimale des demi-teintes	1 pt (0.35 mm)	—————
Pourcentage de demi-teinte		

	SÉRIGRAPHIE		HOT STAMPING / EMBOSSAGE		LASER	
Texte positif minimum	6 pt (2.1 mm)	6 Point text	10 pt (3.5 mm)	10 Point text	6 pt (2.1 mm)	6 Point text
Texte négatif minimum	9 pt (3.1 mm)	9 Point text	15 pt (5.25 mm)	15 Point	NON RECOMMANDÉ	
Épaisseur minimale des lignes positives	0.4 pt (0.14 mm)	—————	1.5 pt (0.5 mm)	—————	0.3 pt (0.1 mm)	—————
Épaisseur minimale des lignes négatives	0.5 pt (0.176 mm)	—————	2 pt (0.706 mm)	—————	0.5 pt (0.17 mm)	—————
Épaisseur minimale des demi-teintes	1.5 pt (0.5 mm)	—————	PAS POSSIBLE		PAS POSSIBLE	
Pourcentage de demi-teinte	50%	—————				

# INDEX DES PRODUITS

## INSTRUMENTS D'ÉCRITURE BIC®

BIC® Cristal® Expression _____	38
BIC® Cristal® Re'New™ _____	40
BIC® Cristal® Re'New™ Black _____	42
BIC® Style _____	44
BIC® Round Stic® _____	48
BIC® Round Stic® Ecolutions® _____	51
BIC® M10® Clic _____	54
BIC® Media Clic _____	60
BIC® Media Clic Advance _____	58
BIC® Media Clic Ecolutions® _____	61
BIC® Media Clic Ecolutions® Plus _____	62
BIC® Media Clic Grip _____	65
BIC® Media Clic Grip Ecolutions® _____	66
BIC® Media Clic BGuard™ antibactérien _____	70
BIC® Media Clic BGuard™ antimicrobial Ecolutions® _____	72
BIC® Media Clic Biobased Ecolutions® _____	74
BIC® Media Clic Biobased BGuard™ antibactérien _____	76
BIC® Media Clic Shine _____	78
BIC® Media Clic Glacé _____	80
BIC® Clic Stic _____	82
BIC® Clic Stic Ecolutions® _____	83
BIC® Clic Stic Sofffeel® _____	85
BIC® Clic Stic Stylus _____	86
BIC® Clic Stic Stylus Ecolutions® _____	86
BIC® Super Clip _____	92
BIC® Super Clip Ecolutions® _____	93
BIC® Super Clip Advance _____	96
BIC® Super Clip Glacé _____	96
BIC® Super Clip Glacé Advance _____	100
BIC® Super Clip Soft _____	102
BIC® Super Clip Soft Advance _____	103
BIC® Super Clip Origin _____	104
BIC® Wide Body™ _____	108
BIC® Wide Body™ Ecolutions® _____	109
BIC® Wide Body™ Mini Digital _____	110
BIC® 4 Couleurs® _____	116
BIC® 4 Couleurs® ECO _____	118
BIC® 4 Couleurs® Rainbow Decor _____	120
BIC® 4 Couleurs® Bicolor _____	122
BIC® 4 Couleurs® Gradient _____	124
BIC® 4 Couleurs® Pastel _____	126
BIC® 4 Couleurs® Fashion _____	128
BIC® 4 Couleurs® Sun _____	130
BIC® 4 Couleurs® Fine _____	132
BIC® 4 Couleurs® Fluo _____	134
BIC® 4 Couleurs® Glacé _____	136
BIC® 4 Couleurs® Shine _____	138
BIC® 4 Couleurs® Soft _____	140
BIC® 4 Couleurs® Wood Style _____	142
BIC® 4 Couleurs® Flags Collection _____	144
BIC® 4 Couleurs® 3+1 <sup>HB</sup> _____	146
BIC® Metal Pro _____	148

BIC® Grip Roller _____	154
BIC® Intensity® Gel Clic _____	156
BIC® Brite Liner® Grip _____	160
BIC® Highlighter Flat _____	162
BIC® Velleda® White Board Marker Fine _____	164
BIC® Velleda® White Board Marker Grip _____	165
BIC® Mark-It Permanent Marker _____	165
BIC® Permanent Marker Ecolutions® _____	167
BIC® Matic® _____	170
BIC® Media Clic Porte-mines _____	172
BIC® Media Clic Grip Porte-mines _____	173
BIC® Media Clic Grip Ecolutions® Porte-mines _____	173
BIC® Evolution® Ecolutions® _____	178
BIC® Kids Evolution® Colouring Set _____	182
Sprout™ Crayon Graphite _____	184

## AUTRES INSTRUMENTS D'ÉCRITURE

Basic Pen _____	190
Click Pen _____	192
Striped Grip Pen _____	194
Sleek Stylus Pen _____	198

## BIC® PARTNER

BIC® Partner Hard Cover _____	204
BIC® Partner Flex Cover _____	206
BIC® Partner FruitCover _____	208
BIC® Partner Carnets Tailormade Service _____	210

## BRIQUETS ET ÉTUIS BIC®

BIC® J25 Briquet _____	218
BIC® J23 Briquet _____	222
BIC® J26 Briquet _____	226
BIC® J38 Briquet _____	230
BIC® EZ Reach™ Briquet _____	234
BIC® Styl'it Luxury Case _____	238
BIC® Aluminium Flat Case _____	240
BIC® Clip Étui _____	241
BIC® 3D Étui _____	242
BIC® Cendrier de Poche _____	244

## BRIQUETS DJEEP®

DJEEP® D1 Briquet _____	248
-------------------------	-----

## EMBALLAGES BIC®

Emballage Primaire BIC® Ecolutions® _____	258
Emballage Primaire BIC® _____	258
Emballage Secondaire BIC® _____	264

BIC  
GRAPHIC

INSTRUMENTS  
D'ÉCRITURE BIC®

AUTRES INSTRUMENTS  
D'ÉCRITURE































CARNETS

BRIQUETS BIC®/DJEEP®  
ET ÉTUIS BIC®



















































EMBALLAGES  
BIC®

INFORMATIONS  
GÉNÉRALES

# NUANCIER DE COULEURS

										
<b>01</b> Blanc	<b>1E</b> Blanc recyclé	<b>57</b> Blanc opaque	<b>3C</b> Blanc Bio	<b>01BIO</b> Blanc Bio	<b>1T</b> Blanc polished	<b>51</b> Transparent	<b>69</b> Blanc givré	<b>2E</b> Blanc givré recyclé		
										
<b>8D</b> Jaune pastel	<b>8G</b> Jaune léger	<b>12</b> Jaune	<b>12W</b> Jaune bois	<b>63</b> Jaune givré	<b>6AW</b> Bois naturel	<b>012BIO</b> Jaune Bio	<b>4D</b> Jaune clair	<b>6F</b> Marron clair	<b>6O</b> Jaune pastel	<b>10</b> Sable jaune
										BIC® Partner
										
<b>9C</b> Inspiring Autumn	<b>26</b> Or	<b>76</b> Or glacé	<b>1G</b> Orange acide	<b>10</b> Orange	<b>90</b> Orange pastel	<b>71</b> Orange givré	<b>92</b> Orange clair	<b>10B</b> Orange warm		
										
<b>03</b> Rouge	<b>03G</b> Rouge glacé	<b>03F</b> Rouge doux	<b>8E</b> Rouge recyclé	<b>87</b> Rouge clair	<b>03BIO</b> Rouge Bio	<b>66</b> Rouge givré	<b>08</b> Bordeaux			
										
<b>14A</b> Peaceful Pink	<b>14</b> Rose pétillant	<b>5C</b> Rose pétillant	<b>1P</b> Rose fluo	<b>014G</b> Rose glacé	<b>07</b> Rose or	<b>11</b> Rose	<b>80</b> Rose	<b>97</b> Rose or	<b>98</b> Magenta	
										
<b>84</b> Pourpre pastel	<b>13</b> Lilas	<b>39</b> Pourpre givré	<b>7G</b> Violet métallisé	<b>2D</b> Pourpre	<b>93</b> Pourpre foncé clair	<b>4B</b> Pourpre givré	<b>2M</b> Violet foncé métallisé			

# NUANCIER DE COULEURS

 <b>8C</b> Citron vert	 <b>68</b> Vert givré	 <b>6C</b> Vert herbe	 <b>88</b> Vert clair	 <b>59</b> Vert pomme	 <b>82</b> Vert foncé glacé	 <b>72</b> Vert clair (clear)	 <b>5G</b> Vert clair (opaque)	 <b>05G</b> Vert glacé	 <b>05</b> Vert métallique	
 <b>05</b> Vert	 <b>05W</b> Vert bois	 <b>20</b> Vert foncé	 <b>7E</b> Vert foncé recyclé	 <b>88</b> Vert foncé clair	 <b>05BIO</b> Vert Bio	 <b>3B</b> Vert kaki givré				
 <b>83</b> Bleu pastel	 <b>4M</b> Cozy Blue	 <b>3D</b> Bleu Caraïbes	 <b>86</b> Clear Bleu	 <b>67</b> Bleu glacé	 <b>24</b> Bleu clair	 <b>04BIO</b> Bleu Bio	 <b>04</b> Bleu	 <b>04G</b> Bleu glacé	 <b>40</b> Bleu foncé givré	 <b>4R</b> Bleu turquoise
 <b>34</b> Bleu métallisé	 <b>89</b> Bleu marine clair	 <b>7C</b> Bleu marine métallisé	 <b>25</b> Bleu foncé	 <b>07</b> Bleu marine	 <b>07F</b> Bleu marine recyclé	 <b>10E</b> Bleu marine recyclé				
 <b>35</b> Chrome	 <b>47</b> Argent	 <b>47G</b> Argent glacé	 <b>75</b> Argent métallisé	 <b>18</b> Métal	 <b>06</b> Gris clair	 <b>27</b> Gris foncé	 <b>8H</b> Gris foncé givré	 <b>6W</b> Gris chaud		
 <b>02BIO</b> Noir Bio	 <b>02W</b> Noir bois	 <b>02F</b> Noir doux	 <b>02</b> Noir	 <b>3E</b> Noir recyclé	 <b>2N</b> Noir mat					

Les couleurs ci-dessus ne sont qu'à titre indicatif uniquement.  
La couleur réelle peut varier légèrement selon le produit.

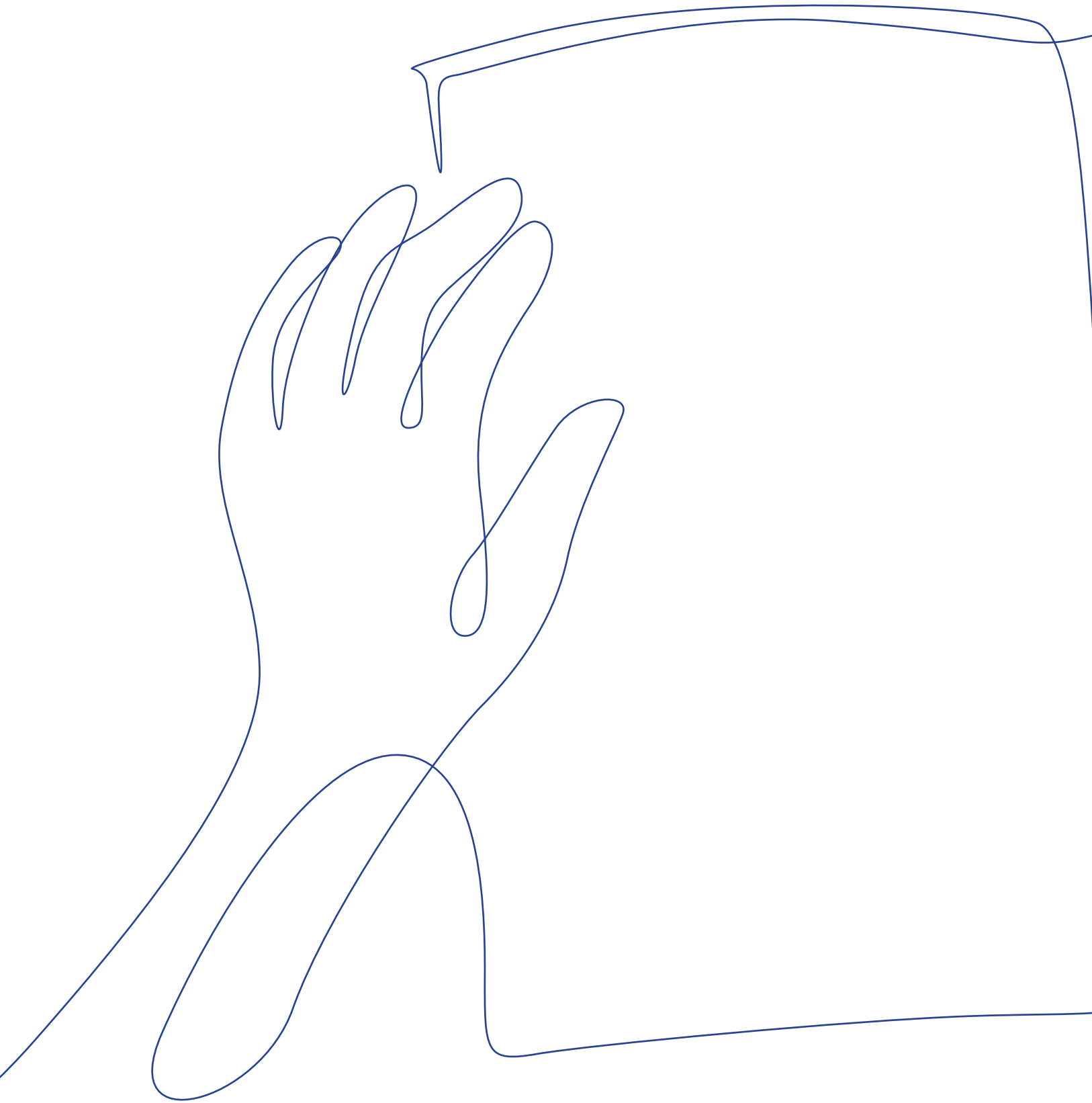



THINK BIG

[www.bicgraphic.com](http://www.bicgraphic.com)





[www.bicgraphic.com](http://www.bicgraphic.com)